



City of Conway Council Agenda

Council Meeting Date:

January 12th, 2016

5:30pm – Committee Meeting

Presentation by Union Pacific: Regarding the potential Closing of Robin Street railroad crossing

Discussion of Amity Road Reconfiguration

6:30pm - Council Meeting

Call to Order: Mayor Tab Townsell

Roll Call: City Clerk/Treasurer Michael O. Garrett

Minutes Approval: **December 22nd, 2015**

Mayor Tab Townsell

City Clerk Michael O. Garrett
City Attorney Chuck Clawson

City Council Members

Ward 1 Position 1 – Andy Hawkins
Ward 1 Position 2 – David Grimes
Ward 2 Position 1 – Wesley Pruitt
Ward 2 Position 2 – Shelley Mehl
Ward 3 Position 1 – Mark Ledbetter
Ward 3 Position 2 – Mary Smith
Ward 4 Position 1 – Theodore Jones Jr.
Ward 4 Position 2 – Shelia Whitmore

1. Report of Standing Committees:

A. Community Development Committee (Planning, Zoning, Permits, Community Development, Historic District, Streets, & Conway Housing Authority)

1. Consideration to enter into a memorandum of agreement with the FAA for the AWOS weather system located at Cantrell Field.
2. Ordinance appropriating funds received from the sale of certain inoperable equipment and scrap metal from the Street & Engineering Department.
3. Consideration to approve a change order (No. #1) for the Oak Street & Central Landing Blvd. Project.
4. Consideration to accept a counteroffer from the Knights of Columbus for the Central Landing Blvd Improvement Project.
5. Resolution(s) to seek condemnation by eminent domain proceeding of certain properties (Roller McNutt right of way) related to the Central Landing Boulevard right of way project. ***(Resolution to be provided prior to meeting.)***
6. Consideration to approve the nomination of Rhiannon Botsford to the Conway Tree Board.
7. Ordinance appropriating grant funds received from the EPA for the Spencer Street Brownfield Cleanup project.
8. Ordinance appropriating proceeds received from Faulkner County for GIS work provided by the Planning & Development Department.
9. Consideration to approve a conditional use permit to allow MF-1 density in an R-2A zoning district for property located at 1919 and 1921 Clifton Street.

10. Consideration to approve a shelter for the homeless in an RMH Zone at property located at 450 E. Robins Street, #21.
11. Consideration to extend the conditional use permit for MFB Investment to operate a clinical treatment center (Phoenix Recovery Center) at property located on Jersey Street.

B. Public Services Committee (Sanitation, Parks & Recreation & Physical Plant)

1. Consideration to enter into an amended agreement with Enable Gas Transmission LLC for pipeline right of way, surface site easement and access road grant near the Conway Landfill.
2. Ordinance authorizing personnel changes within the Conway Parks & Recreation Department
3. Ordinance appropriating funds & approving a professional service contract for Don Owen infields for the Parks & Recreation Department.
4. Ordinance appropriating funds and approving the cost of the materials for the interior finishes for the Conway Event Center.
5. Consideration to enter into a lease agreement with Arkansas Rush to operate Centennial Soccer Park.

C. New Business

1. Resolution adopting the organizational rules and procedures for the Conway City Council FY2016.

Adjournment



City of Conway
Street and Engineering Department

January 5, 2016

Mayor Tab Townsell
City of Conway
1201 Oak Street
Conway, AR 72032

Re: Lewis Ranch

Mayor Townsell,

In order to comply with the tight time schedule requested by Salter Properties, design needs to begin soon on the Lewis Ranch roadways. After lengthy discussions involving Salter Properties and the planning department we agreed upon the the attached cross sections labeled "Option 1".

According to it's founding resolution, "The mission of the Bicycle and Pedestrian Advisory Board (BPAB) will be to work with the city of Conway to recommend ways the city can become and remain 1) an official Bicycle-Friendly Community...2) an official Walk-Friendly Community..., and 3) a community that seeks to achieve the federal and state goals of the Safe Routes to Schools program." To this end, I asked the board to comment on the proposed cross section. After significant debate with no resolution, I submitted an alternative design for consideration and asked the board to recommend which design would most aid in the City's bicycle and pedestrian friendly applications. Unfortunately, while the board has submitted a lengthy recommendation regarding the roadway design, they have been unable to fulfill their stated purpose.

Given that no there is no evidence that any of the BPAB's recommendations would further the City's goal of bicycle and pedestrian friendly status, I do not believe that the added cost associated with their recommendations is worthwhile. As a result, I propose moving forward with the Engineering Department's recommendations for these roadway designs, shown as attached "Option 1".

Sincerely,

A handwritten signature in blue ink that reads "B. Finley Vinson III". The signature is written in a cursive style.

B. Finley Vinson III, P.E.

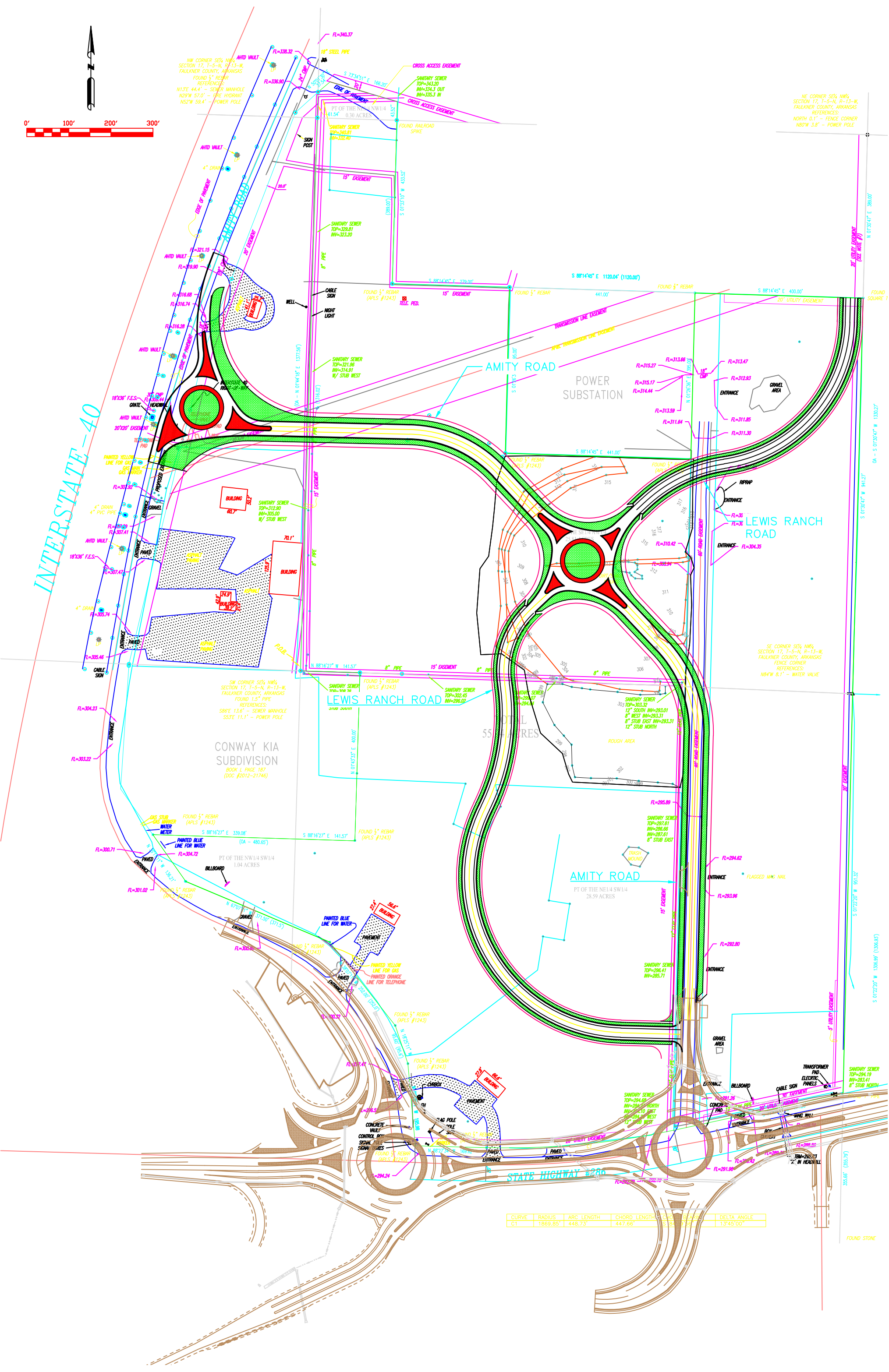
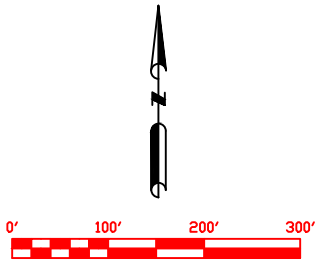

NW CORNER SE 1/4 NW 1/4 SECTION 17, T-5-N, R-13-W, FAULKNER COUNTY, ARKANSAS
 FOUND 5" REBAR
 REFERENCES:
 N13E 44.4' - SEWER MANHOLE
 N22W 52.0' - FIRE HYDRANT
 N52W 59.4' - POWER POLE

NE CORNER SE 1/4 NW 1/4 SECTION 17, T-5-N, R-13-W, FAULKNER COUNTY, ARKANSAS
 REFERENCES:
 NORTH 0.1' - FENCE CORNER
 N80W 3.8' - POWER POLE

SW CORNER SE 1/4 NW 1/4 SECTION 17, T-5-N, R-13-W, FAULKNER COUNTY, ARKANSAS
 FOUND 1.5" PIPE
 REFERENCES:
 S86E 13.6' - SEWER MANHOLE
 S33E 11.1' - POWER POLE

SE CORNER SE 1/4 NW 1/4 SECTION 17, T-5-N, R-13-W, FAULKNER COUNTY, ARKANSAS
 FENCE CORNER
 REFERENCES:
 N84W 8.1' - WATER VALVE

CURVE	RADIUS	ARC LENGTH	CHORD LENGTH	CHORD BEARING	DELTA ANGLE
C1	1869.85'	448.73'	447.66'	S 86° 33' 55" E	13° 45' 00"

FOUND STONE

Amity Road (Option 1)



Amity Road (Option 2)

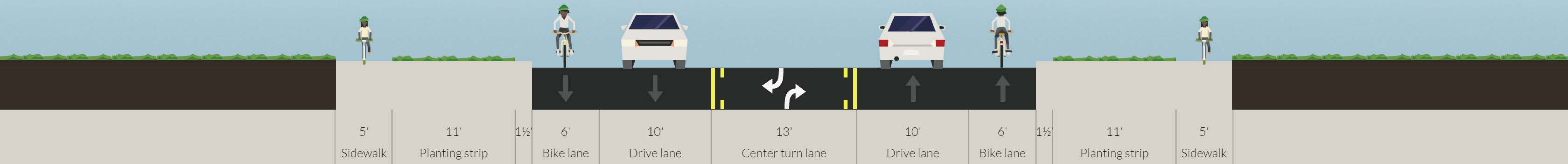

Lewis Ranch Road (Option 1)



Lewis Ranch Road (Option 2)





Amity Road Reconfiguration and Lewis Ranch Road

Bicycle and Pedestrian Design Recommendations

November 25, 2015

Conway Arkansas Bicycle & Pedestrian Advisory Board

Todd Ake – Chair
Amanda Potter Cole – Vice-Chair
Greg Reddin - Secretary

Jim Bruce
Scott Lucas
Peter Mehl
Matthew Murphy

Jessica Henry Spade
Michael Yoder
Emily Walter

Amity & Lewis Ranch Roads *Bicycle & Pedestrian Design Recommendations*

Introduction

The City of Conway Bicycle and Pedestrian Advisory Board (BPAB) submits the following design recommendations to the City of Conway regarding the reconfiguration of Amity Road and the newly proposed Lewis Ranch Road located north of Highway 286 and east of Interstate 40. Reference the drawing provided at the end of this document.

The Board is pleased to be consulted by the Street Department and that pedestrian and bicycle accommodations have been taken in account in the initial design offerings.

Context of the Site Being Developed

- Residential housing currently exists to the north of the development.
- Although the final development plans have not been submitted, the properties being served by this section of the relocated Amity Road and the proposed Lewis Ranch Road are expected to be primarily commercial, including retail shopping, an existing automobile dealership, and two existing mobile home dealerships.
- The proximity of interstate 40 entrance & exit ramps, future development of properties south of Highway 286, (a.k.a. the Lewis Crossing development) will likely lead to significant vehicular traffic. This traffic will likely include a significant number of motorists not familiar with Conway or the respect for cycling culture we are attempting to permeate.
- This area is expected to be readily accessible from the northwest by bicyclists and pedestrians via the new overpass located from the old airport to Amity Road at Middle Road. This overpass will include a multi-use path.
- Available Right of Way is limited to 48' of pavement; 80' total on the relocated Amity Road and 60' total on the proposed Lewis Ranch Road.
- We understand the developer is open to limiting the number of curb cuts/driveways off of both roads.
- We envision the majority users of this bike & pedestrian infrastructure to be employed within the development or traveling through it. At this time, we do not envision it being used significantly by recreation cyclists or runners/joggers.

Design Considerations

In the effort to make this a safer route for cyclists and pedestrians, the board recommends these design considerations:

- On-street bike lanes in each direction
 - 5 feet wide; curb/gutter structure not included in width of bike lane.
 - Demarcated from traffic with a 2' painted (e.g. diagonally striped) buffer.
 - Marked with bicycle symbols every 250 feet.
 - Bike lane to ramp up to meet multi-use paths (if built) giving bicyclists smooth transitions from on street travel to the multi-use path.

Amity & Lewis Ranch Roads *Bicycle & Pedestrian Design Recommendations*

- Sidewalks on both sides of each road.

Accommodations for pedestrians should be made on both sides of the road as it is unforeseen how development will take place through this corridor at this time. For sidewalk design we point to the Safe Route To Schools recommendations found here

<http://guide.saferoutesinfo.org/engineering/sidewalks.cfm> and should include the following:

- 6' wide;
 - Separated from the street with a minimum 5' green space buffer;
 - Sidewalks should continue across driveways (parking lot entrances) at the same elevation or 'level', and the driveway apron should not go through the sidewalk.
 - It would be preferred that sidewalks were of a different material and/or different color than the driveways.
- Adequate Street Lighting to improve pedestrian & bicyclist visibility and personal security.

Concerns

When reviewing the Amity Road and Lewis Ranch Road plans it was noted that the design of the renovated Highway 286/Dave Ward Drive appears to have no accommodations for bicyclists or pedestrians. We encourage the city to contact the Arkansas State Highway and Transportation Department urging them to address these concerns:

- Provide pedestrian & bicyclist crossing of Highway 286, preferably by separated grade so that the users can safely travel between this new development and the Lewis Crossing development.
- Provide pedestrian and bicycle infrastructure (possible 8-10' side paths) so that both this development and the Lewis Crossing development can be safely accessed from the east.

Conclusion

The Bicycle and Pedestrian Advisory Board continues to be enthused that the City of Conway has embraced the Complete Streets design model. Developing safe bicycle and pedestrian infrastructure will encourage more users, resulting in less vehicular traffic.

Amity & Lewis Ranch Roads Bicycle & Pedestrian Design Recommendations

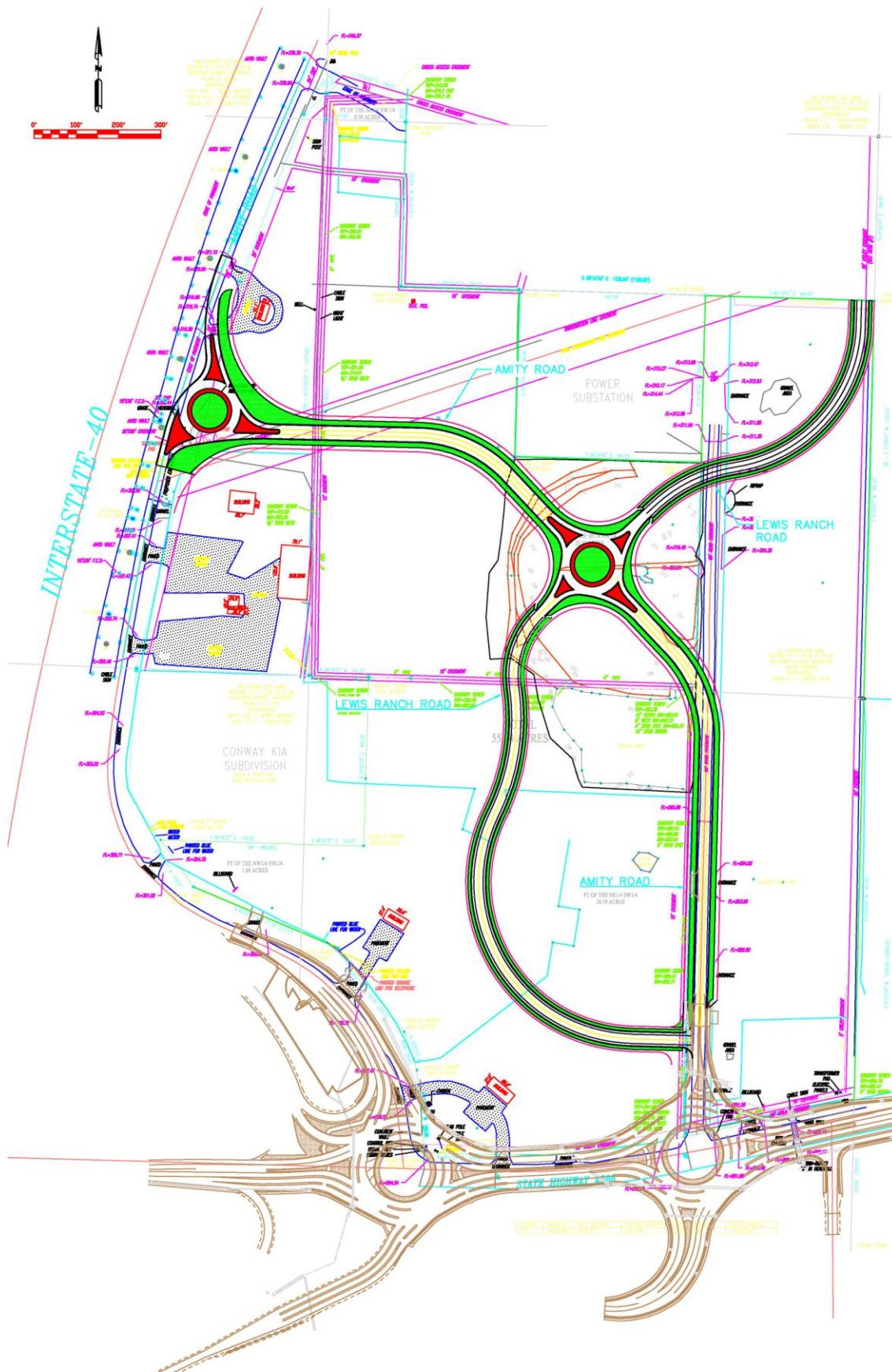

MEMO

To: Mayor Tab Townsell
Conway City Council

From: Josh Zylks, Cantrell Field

Date: 05 January 2016

Subject: Approval of AWOS MOA/Maintenance Agreement

The attached document is a Memorandum of Agreement for the Operations and Maintenance agreement with the FAA for the AWOS Weather System at Cantrell Field. In short, the agreement provides that we will provide airfield access to the equipment for FAA personnel whenever they need to come out and work on it. Further, we are agreeing to only schedule maintenance shutdowns during periods of forecasted good weather.

Please advise if you have any questions.

KC TSC
1701A Bond Street
Little Rock, AR 72202

Mr. Josh Zylks
Conway City Mayor
Conway Airport Manager
3250 Sand Gap Road
Conway, AR 71754

Dear Mr. Zylks,

The attached documents for your records include the Memorandum of Understanding between the Federal Aviation Administration and the City of Conway, and the Operations & Maintenance Manual for the Conway Automated Weather Observation System (CXW AWOS), serving the Conway Municipal airport.

After your review, please sign and date the Memorandum of Agreement and return it to this FAA office. A signed copy will be returned to you for your records.

If you have any questions concerning this Memorandum of Understanding and Operations & Maintenance Manual, please contact John Schrock of the KC Technical Support Staff, telephone (501) 681-5434.

Sincerely,

John Schrock
KC TSC

Enclosure

MEMORANDUM OF UNDERSTANDING
Between the
Federal Aviation Administration
And
The City of Conway, Arkansas
Owner / Sponsor

In accordance with the requirements of FAR 171, the

City of Conway, Arkansas
(Owner/Sponsor)

Having installed the

CXWAWOS at **Conway Municipal Airport**
(ID/Facility) (Location/Airport)

Hereby submits the enclosed Operations and Maintenance Manual for approval by the Federal Aviation Administration.

The undersigned agree to operate and maintain the above facility in accordance with all Federal Aviation Administration requirements, standards, and criteria governing such facility, including those requirements contained in FAR 171, the enclosed Operations and Maintenance Manual, and the Manufacturer's Instruction Book.

At any time that the undersigned or persons named in the Operations and Maintenance Manual are no longer performing the functions indicated, the Federal Aviation Administration shall be notified within 10 working days.

The undersigned understand that non-compliance with the above requirements will be grounds for NOTAMing the facility out-of-service and/or cancellation of Federal Aviation Administration approved instrument flight rules procedures.

With regard to any liability which may arise from the use and/or the operation of this facility, each party expressly agrees that it shall be solely and exclusively liable for the negligence of its own agents, servants and/or employees, in accordance with applicable law, and that neither party looks to the other to save or hold it harmless for the consequences of any negligence on the part of one of its own agents, servants, and/or employees.

Signature: _____ Date:
(Owner or Designated Representative)

Signature: John Schrock Date: 12/2/2015
(FAA Representative)

Enclosure: (Operations and Maintenance Manual)

Operations and Maintenance Manual

CXW

(Facility Identifier)

AWOS

(Facility Type)

Conway Municipal Airport

(Location)

This manual is prepared to fulfill the requirements of Federal Aviation Regulations, Part 171. The applicable Subpart B is incorporated herein (pages 10-17). In all cases however, Subpart E and pertinent amendments also apply.

Table of Contents

Part

I. Operational Requirements

II. Maintenance Requirements

III. Aircraft Accident / Incident Procedures

IV. Nonfederal Facility Data

*Attachment 1 FAA Advisory Circular 150/5220-16D AWOS System Maintenance and Operating Requirements
Can be found on pages 65-72.*

**PART I
OPERATIONAL REQUIREMENTS**

1. LICENSING

- a. **Facility** The FCC license is to be conspicuously posted at the facility. The normal period of the license is 10 years, after which it must be renewed. FCC Form 406A may be obtained from the FCC for license renewal. Each application must contain a statement indicating that the FAA has been notified and the date of notification.
- b. **Maintenance Technician** Equipment operation and maintenance shall be performed only by Persons duly licensed by the FCC and approved by the FAA, respectively.
 - (1) A general class radio telephone operator license satisfies the FCC requirement
 - (2) FAA approval is granted upon the successful completion of both of the following:
 - (a) FAA or manufacturer's school, or satisfactory completion of a theory exam to be administered by a representative of the FAA. The satisfactory completion of the theory exam precludes the necessity of resident training.
 - (b) A practical exam to be given by a representative of the FAA.
 - (3) The FAA stating that these requirements have been met will provide a letter of technical verification.

2. NOTICE TO AIRMEN

- a. A Notice to Airmen (NOTAM) contains the establishment, condition, or change in any aeronautical facility, service, procedure, or hazard. NOTAM's are very time critical to personnel concerned with flight operations. NOTAM information must be personally conveyed to the FAA flight service station.

3. MONITORING

- a. It is FAA policy that a monitoring system be provided for all electronic navigational facilities used in support of instrument flight procedures. For AWOS facilities, internal monitoring should be provided that defines the specific weather parameter as "missing" when an out of tolerance condition exists.
- b. Upon receipt of a "missing" weather parameter, responsible AWOS monitoring personnel shall notify the FAA Maintenance Operation Control Center (MOCC) listed in attachment 2 and the owner or "technician of record" for the facility.
- c. At any time the system is not monitored on a continuous basis, the MOCC shall be notified and a NOTAM shall be issued to the effect that this navigational aid is "out of service". This shall not be construed as a release from responsibility for continuous monitoring, but rather as a procedure for public notification upon system failure.

4. SHUT DOWN FOR ROUTINE MAINTENANCE

- a. Maintenance should be performed only when the following conditions exist:
 - (1) Visual flight rules (VFR) conditions.

- (2) Interruption shall be confined to daylight hours.
- (3) Interruption of service is to be coordinated with the Maintenance Operations Control Center (MOCC) listed in attachment 2. Notification should be made so that the notice of shut down or interruption will be published in advance of the proposed interruption.
- (4) A message NOTAM shall be in effect announcing the proposed interruption to occur, and the facility will not be shut down until that specified time. The advance notification of interruption will state a specific period of time for the interruption to occur.

5. **PILOT REPORTS**

- (a) The owner shall remove the facility from service immediately upon receipt of two successive pilot reports (PIREPS) of facility malfunction. The facility will remain out of service until proper operation can be confirmed by the facility “technician of record”, and/or FAA flight inspection aircraft, if necessary.

6. **REQUIRED SUPPORT ITEMS**

- (a) Properly calibrated test equipment required for maintenance of the facility shall be types approved by the FAA. There shall be a stock of spare parts, sufficient to make possible prompt replacement of components which fail in service. All test equipment calibration procedures shall be approved by the FAA.

7. **EMERGENCIES**

- (a) In case of a national defense alert, the facility shall be shut down in the shortest possible time after the alert is received from the air traffic facility and shall remain off the air until official notice is received that the alert is over.
- (b) Part III of this agreement provides guidance in the event of aircraft accident.

**PART II
MAINTENANCE REQUIREMENTS**

1. GENERAL

- (a) The facility shall be installed and maintained in accordance with the following documents:

FAA Advisory Circular AC 150/5220-16D and AWOS Equipment Manufacturer's Instruction Book

NOTE: The maintenance schedules and requirements contained in these publications are to be considered the minimum level of maintenance.

- (b) Forms and publications required for maintenance of the facility will be provided by the FAA, or the applicable AWOS equipment manufacturer's instruction book .
- (c) If a maintenance technician is unavailable for any reason, or if the maintenance schedules prescribed by the applicable AWOS equipment manufacturer's instruction book are not adhered to, the equipment shall be removed from service unless the owner or owner's representative has coordinated the exact circumstances with the FAA.
- (d) Facility Maintenance Log, FAA Form 6030-1 is a permanent record of all activities required to maintain the facility. The log entries must include all malfunctions encountered in maintaining the facility, including information about adjustments made, equipment failures, causes of failure and corrective action taken. In addition, the log entries must include required periodic maintenance completion, AWOS facility verification statements and any NOTAM information. The owner or owner's representative must keep the original of each form at the facility and send a copy to the FAA Airway Facilities office every six months.
- (e) Technical Performance Record contains a record of system parameters recorded in each scheduled visit to the facility. Applicable forms from the manufacturer's instruction book may be utilized in lieu of this FAA form. The owner or owner's representative should submit these forms to the FAA Airway Facilities office with the facility maintenance logs.
- (f) The owner shall submit to the FAA, for approval, any proposed modification to the facility and shall not permit any modifications to be performed without specific FAA approval.
- (g) Neither the transmitter nor the antenna will be relocated without FAA approval. No construction is to be planned in the vicinity of the facility that may alter or affect the facility without prior coordination with the FAA.

2. PHYSICAL SECURITY

- (a) The facility shall be kept locked at all times. Facility fencing is recommended to reduce potential liability and to deter unauthorized access to the equipment.

3. FAA GROUND INSPECTIONS

- (a) FAA technical ground inspections will be accomplished on a periodic basis to determine facility health and periodic maintenance completion. The FAA may conduct an inspection when the facility may have been a factor in an aircraft accident (see PART III).

Facility Performance
and
Adjustment Data Cover Sheet

Orig. (X)
Rev. ()

Location Conway Municipal Airport

Date 12/2/2015

Sheet # Date Revised

Reason for Revision

**PART IV
NON-FEDERAL FACILITY DATA**

A. Facility

- (1) *Type* *Automated Weather Observation System (AWOS II)*
- (2) *Manufacturer* *All Weather, Inc.*
- (3) *Facility Name* *Conway Municipal AWOS*
- (4) *Airport Name* *Cantrell Field*
- (5) *Directions to Facility* *3250 Sand Gap Road, Conway, AR 72034*
- (6) *Facility Elevation* *270.24 Feet MSL (AWOS Tower Foundation)*
- (7) *Latitude* *35*01' 17.2 " North*
- (8) *Longitude* *92* 33' 26.5 " West*
- (9) *Frequency* *118.775 MHz (A/G) 453.1125 MHz (Data Link)*
- (10) *FCC Licensed Power* *2.5 Watts (A/G) 2 Watt (Data Link)*

B. POINTS OF CONTACT

- (1) *Sponsor* *City of Conway*
- (2) *Sponsor's Representative:*
- (a) *Name/Title* *Josh Zylks, Airport Manager*
- (b) *Telephone* *Work (501) 358-6200*
- (c) *Address* *Conway Municipal Airport*
3250 Sand Gap Road
Conway, AR 72034

(3) Facility Technician:

(a) Name **Ron Rollins**

(b) Telephone **(816) 896-3251**

(c) Address **911 NW Valley Lane**
Riverside, MO 64150-9463

(4) Associated MOCC Telephone Number **866-432-2622**

(5) Associated FAA Airway Facilities Office/address/telephone

Kansas City Technical Support Center

1701A Bond Street

Little Rock, AR 72202

Phone: (501) 681-5434

Contact : John Schrock

(6) Communications Arrangements for Aircraft Accidents

Contact John Schrock at phone (501) 681-5434.



**City of Conway, Arkansas
Ordinance No. O-16-_____**

AN ORDINANCE APPROPRIATING FUNDS FOR THE CITY OF CONWAY STREET & ENGINEERING DEPARTMENT; AND FOR OTHER PURPOSES

Whereas, the City of Conway Street & Engineering Department received two checks, check number 21932 in the amount of \$17,00 and check number 21933 in the amount of \$500.00 from Little Rock Truck Parts, LLC for the purchase of scrap metal and inoperable equipment; and

Whereas, both checks have been receipted into account number 002-201-4611 (Sale of Street Assets); and

Whereas, the City of Conway Street & Engineering Department seeks to appropriate these funds into the Machinery & Equipment account (002-201-5910), to aid in the purchase of replacements.

NOW THEREFORE BE IT ORDAINED BY THE CITY COUNCIL OF THE CITY OF CONWAY, ARKANSAS, THAT:

Section 1. The City of Conway shall appropriate funds in the amount of \$17,500 from the Sale of Street Assets Account (002-201-4611) to the City of Conway Street & Engineering Department Machinery & Equipment Account (002-201-5910).

Section 2. All ordinances in conflict herewith are repealed to the extent of the conflict.

PASSED this 12th day of January, 2016.

Approved:

Mayor Tab Townsell

Attest:

**Michael O. Garrett
City Clerk/Treasurer**

**CONWAY, ARKANSAS
CANTRELL FIELD ACCESS**

**HWY. 64 INTCHNG TRAFFIC OPERATIONS IMPROVEMENTS (CONWAY)(S)
CONWAY, ARKANSAS
AHTD Job 080518**

CHANGE ORDER 1

CONTRACTOR
Mobley Contractors, Inc
P.O. Box 150
Morrliton, Arkansas 72110-0150

DATE: January 12, 2016

A. PURPOSE

The purpose of this Change Order No. 1 is to issue revised Project Plans and revise the Unit Price Schedule to reflect changes made in the storm drainage system crossings of Oak Street (U.S. HWY 64) to reduce the number of street crossings and thus reduce the impact on Oak Street Traffic.

B. PLANS

Replace Project Plan Sheets 15, 17, 19, 21, 24, 25, 27, 29-31, 44-46, 53, 55-60,148, 149, 153, and 154 with revised sheets of the same number and dated Revised 11-24-15.

**C. SPECIFICATIONS AND CONTRACT DOCUMENTS
UNIT PRICE SCHEDULE**

Revise the Unit Price Schedule to reflect the change in quantities of work and additional items of work required by the above referenced plan revisions. The revised item of the Unit Price Schedule to read as follows:

CITY OF CONWAY
HWY 64 INTCHNG. TRAFFIC OPERATIONS IMPVTS. (CONWAY)(S)
UNIT PRICE SCHEDULE

ITEM No.	REF. SPEC	DESCRIPTION	UNITS	UNIT PRICE	ORIGINAL QUANTITY	ORIGINAL AMOUNT	REVISED QUANTITY	REVISED AMOUNT
8	201	Remove & Disposal of Pipe Culverts	Each	\$1,030.78	2	\$2,061.56	1	\$1,030.78
50	605	Concrete Ditch Paving (Type B)	SQ. YD.	\$34.52	744	\$25,682.88	1,131	\$39,042.12
52	606	18" RCP (Class III)	L.F.	\$78.17	1435	\$112,173.95	1540	\$120,381.80
53	606	24" RCP (Class III)	L.F.	101.94	334.00	\$34,047.96	531	\$54,130.14
55	606	30" RCP (Class III)	L.F.	\$97.39	145	\$14,121.55	0	0.00
59	606	51"X 31" RCP Arch (Class III)	L.F.	\$143.16	290	\$41,516.40	0	0
61	606	24" Flared End Section for RCP	Each	\$1,786.70	7	\$12,506.90	11	\$19,653.70
62	606	30" Flared End Section for RCP	Each	\$2,051.41	2	\$4,102.82	0	0.00
66	606	51"X 31" Flared End Section for RCP Arch	Each.	\$4,029.25	4	\$16,117.00	0	0
68	609	Drop Inlets (Type C)	Each	\$5,187.00	2	\$10,374.00	3	\$15,561.00
76	615	Pavement Repair Over Culverts (Asphalt)	Ton	\$278.16	223	\$62,029.68	111	\$30,875.76
85	620	Water	MGAL	\$5.25	1044.6	\$5,484.15	1,047.60	\$5,499.90
89	621	Drop Inlet Silt Fence	L.F.	\$9.98	520	\$5,189.60	540	\$5,389.20
96	624	Solid Sodding	SQ. YD.	\$3.78	6,726	\$25,424.28	6,974	\$26,361.72
172	606	44"X 27" RCP Arch (Class III)	L.F.	\$133.50	0	0	151	\$20,158.50
173	606	44"X 27" Flared End Section for RCP Arch	Each	\$2,930.79	0	0	2	\$5,861.58
TOTAL						\$370,832.73		\$343,946.20
Underrun								\$26,886.53

D. AGREEMENT

The contract dated October 21, 2015 between the City of Conway, Arkansas and Mobley Contractors, Inc. for the HWY 64 INTCHNG. TRAFFIC OPERATIONS IMPVTS. (CONWAY)(S), Conway, Arkansas is hereby modified and changed to reflect the above described changes in work and prices. The total estimated contract amount is decreased by \$26,886.53 from \$5,283,458.30 to \$5,256,571.47 by this change order. By signature below the City and Contractor hereby agree to amend the contract to include the modification described in this Change Order No. 1.

CONTRACTOR:
MOBLEY CONTRACTORS, INC.
BY _____

TITLE _____

ATTEST _____

DATE _____

OWNER:
CITY OF CONWAY, ARKANSAS
BY _____

Tab Townsell

TITLE Mayor _____

ATTEST _____

DATE _____



MEMO

To: Mayor Tab Townsell

Cc: City Council Members

From: Finley Vinson, P.E.

Date: January 5, 2016

Re: Knights of Columbus Counter Offer

On behalf of the City of Conway, O.R. Colan presented an offer on November 18, 2015 to the Knights of Columbus of \$207,389 for the purchase of right-of-way, temporary construction easement and fencing necessary for the construction of the central landing roadway improvements.

The Knights of Columbus have responded with the attached counter offer. The offer requests 615 feet of additional fencing at a cost of \$10,044 and a landscaping allowance of \$53,700. The landscaping estimate is attached as well.

Please advise how you would like to proceed.



Conway Columbus Club, INC.
Father Dellert Council 4143
514 E. 6th St
Conway AR 72032

12/18/2015

Dear Ms. Mears,

In reference to the City of Conway's counter offer dated November 18th, 2015, received from O.R. Colan & Associates regarding property belonging to Knights of Columbus Council 4143 located at the corner of 5th Avenue & 6th st. (514 E. 6th St.) Conway, AR

The Knights of Columbus has reviewed and agree to the following:

Right of Way Acquisition

- 59,254 SqFt @ \$3.50 per SqFt = **\$207,389.00**

Temporary Construction Easement

- 8,400 SqFt = **\$ 5,880.00**

Due to the fact that the City's offer only accounted for 245 Ft of fence, (which does not protect our property along the new Central Landing Boulevard), we are asking that the fence allowance be changed to 860 Ft., (245 Ft along 6th St and 615 Ft on the east side of our property along the new boulevard)

Fence

- 860 Ft @ \$16.33 per Ft **\$ 14,044.00**

In light of the fact that the Halter property received compensation for the loss of large trees and landscaping, the Knights of Columbus is asking for reimbursement for this as well.

Landscaping & Loss of Large Trees **\$ 53,700.00**

Quote from "The Plant Outlet" included for review

Total Compensation Requested **\$281,013.00**

Additionally, we would ask that the City provide the following as stated in their counter offer:

1. Keep street watered during construction to reduce the potential for dust blowing onto the Knights of Columbus pool area.
2. Construct driveway (concrete), off 5th Avenue to Northwest corner of existing parking lot.
3. Construct driveway off new Central Landing Boulevard to existing parking lot (concrete apron with gravel road to existing lot).

The Knights of Columbus Council 4143 wishes to resolve this property acquisition as soon as possible. If we can assist with further questions, please feel free to contact us via email:

Michael Kordsmeier – mkordsmeier85@gmail.com

Chris Hoyt – chris@htnetventures.com

Sincerely,

A handwritten signature in blue ink that reads "Chris Hoyt". The signature is written in a cursive style with a large initial "C" and a long horizontal stroke at the end.

Chris Hoyt
Grand Knight
Knights of Columbus Council 4143
Conway AR



The Plant Outlet

6182014

P.O. Box 10527
Conway, AR 72034
PH: (501) 513-0080
Fax: (501) 513-0070

Estimate

Customer

Name **Knights of Columbus**
Address **514 E 6th Street**
City **Conway** State **AR** ZIP **72034**
Phone htnetventures@gmail.com

Date **12/18/2015**
Customer **Chris**
Rep **Brett Battle**
Phone # **269-4215**

Qty	Description		Total
	Replacement Value Of Trees Being Taken Down		
11	40-50' Medium Oak Trees (Replaced with 15-18' trees Deliverd and installed Tree Tr	\$1,200.00	\$13,200.00
2	60-100' Oak Trees (Replaced with 6" Caliper 15-18' Delivered and Installed Tree Truc	\$1,500.00	\$3,000.00
25	Large Pine trees 80-90'	\$1,500.00	\$37,500.00
<p>These Trees are just a replacement tree. This is the only way I can value them The EXISTING trees are worth substantially more as they are mature fully grown trees, with tremendous shade value</p> <p>We have bid the cost of a tree transplant truck to transplant in a 6-7" caliper tree. This would be the biggest tree that would be capable of transplanting succesfully</p>			
		Sub Total	\$53,700.00

Payment Methods	
<input type="radio"/> Cash	\$58,398.75
<input checked="" type="radio"/> Check	\$58,398.75
<input type="radio"/> Credit Card	\$60,150.71
3% Additional Charge for Credit Card Use	

Sub Total	\$53,700.00
Arkansas	\$4,698.75
TOTAL	\$58,398.75

All Landscape Accounts Due on Completion

**Our Quality and Service Will Not Be Beat.
You Can Always Reach us at The Nursery
We Guarantee your Satisfaction**

Excellent Quality at a Great Price

Conway's Full Service Nursery

Resolution to seek condemnation by eminent domain proceeding of certain properties (Roller McNutt right of way) related to the Central Landing Blvd. project.

Resolution will be provided prior to the meeting.



CONWAY PLANNING COMMISSION

1201 OAK STREET CONWAY, AR 72032 (501) 450-6105

MEMO

To: Mayor Tab Townsell
CC: City Council Members

From: Kami Marsh, Conway Tree Board, Chairman

Date: January 5, 2016

Re: Nomination for Conway Tree Board

The Conway Tree Board voted unanimously to submit the name Rhiannon Botsford for approval to serve on the Conway Tree Board for a three (3) year term, expiring 12/31/2018. The Conway Tree Board requests that this name be voted on at your next regularly scheduled meeting.

Please advise if you have any questions.



City of Conway, Arkansas
www.cityofconway.org
Board/Commission Nomination Form

RECEIVED
JUL 22 2015
BY: Sharon Kizer

Date: 7/8/15

Board applying for: (One board per form)

Conway City Tree Board

(If you are applying for more than one board, you will only need to fill out the second page once.)

Person Nominated: Rhiannon Botsford
Address: 2825 Pebble Beach Rd #3 city, State, Zip Conway, AR, 72034
Phone/Home: 870-918-1359 Work: 501-932-3054

Person making nomination: Gerry Conley
Address: _____
Phone/Home: _____ Work: _____

Please send to: Michael O. Garrett
City Clerk/Treasurer
1201 Oak Street
Conway, AR 72032
(501) 450-6100
(501) 450-6145 (f)

Please provide the following information for consideration to a City of Conway Board/Commission.

List community/civic activities. Indicate activities in which you (or your nominee) are or have been involved.

Donated space for charity events: Women's Shelter of Conway, Bethlehem House. Law Enforcement of Conway
Volunteered time to execute charity events
Friends of Children's Advocacy Alliance
Conway Crawfish Grant - President

Indicate why you (or your nominee) are interested in serving on this board or commission and what other qualifications apply to this position.

As a graduate of UCA and a long time resident of Conway, I would like to continue my involvement in the community by joining the Conway City Tree Board in order to continue the agricultural and aesthetic development of this beautiful city.

What contributions do you hope to make?

I hope to contribute by adding my expertise in marketing and media - in order to draw attention to the Tree Board's many efforts and expand its membership.

Please feel free to attach to this application any additional information.

The City of Conway strives to ensure all City Boards/Commissions are a representative of our diverse community. To assist in these endeavors; please provide the following information on a voluntary basis:

Age: 33 Sex: F Race: White

Occupation: Self-employed and local business manager Ward: _____

Email Address: NikiRhi@hoinmail.com

Nikie Mann
Signature of Applicant or Nominator

7/8/15
Date



City of Conway, Arkansas
Ordinance No. O-16-_____

AN ORDINANCE APPROPRIATING GRANT FUNDS FOR THE SPENCER STREET BROWNFIELD CLEANUP PROJECT; AND FOR OTHER PURPOSES;

Whereas, grant funds in the amount of \$6,216 were received from the U.S. Environmental Protection Agency in support of the Spencer Street Brownfield Cleanup Project and for other expenses.

NOW, THEREFORE, BE IT ORDAINED BY THE CITY COUNCIL OF THE CITY OF CONWAY ARKANSAS THAT:

Section 1: The City of Conway, Arkansas, shall accept grant funds in the amount of \$6,216 and appropriate said funds from Federal Miscellaneous Grant Account (399-000-4200) to the Planning & Development Grant Account (399-105-5799).

Section 2: All ordinances in conflict herewith are repealed to the extent of the conflict.

PASSED this 12th day of January, 2016.

Approved:

Mayor Tab Townsell

Attest:

Michael O. Garrett
City Clerk/Treasurer



City of Conway, Arkansas
Ordinance No. O-16-____

AN ORDINANCE ACCEPTING PROCEEDS FROM FAULKNER COUNTY FOR GIS (GEOGRAPHIC INFORMATION SYSTEM) WORK IN UPDATING FAULKNER COUNTY GIS DATA, PER INTERLOCAL AGREEMENT (R-11-71) AND APPROPRIATING FUNDS FOR GIS PURPOSES WITHIN THE PLANNING AND DEVELOPMENT DEPARTMENT, AND FOR OTHER PURPOSES:

Whereas; Faulkner County has agreed that it is in the best interests of Faulkner County to contract with Conway to extend the operation of GIS under an arrangement to Faulkner County. These proceeds will provide funding for updates to the Conway GIS including but not limited to GIS software, maintenance, and asset upgrades. No city match is required as part of this agreement; and

Whereas; Faulkner County has provided an agreement in the amount of \$14,000 for the cost of work performed by the Conway GIS Coordinator for GIS updates and map updates to be disbursed quarterly (Invoice January 15th, April 15th, July 15th, October 15th) in calendar year 2016.

NOW, THEREFORE, BE IT ORDAINED BY THE CITY COUNCIL OF THE CITY OF CONWAY, ARKANSAS:

Section 1: The City of Conway shall accept proceeds from Faulkner County in the amount of \$3,500 each quarter (total of \$14,000 for year) and appropriate said funds from (399-000-4200, Miscellaneous Grant Fund Revenue Account); into the following account:

\$14,000 **399-105-5799 (Project E)**

Section 2. All ordinances in conflict herewith are repealed to the extent of the conflict.

PASSED this 12th day of January, 2016.

Approved:

Mayor Tab Townsell

Attest:

Michael O. Garrett
City Clerk/Treasurer



CONWAY PLANNING COMMISSION

1201 OAK STREET CONWAY, AR 72032 (501) 450-6105

MEMO

To: Mayor Tab Townsell
CC: City Council Members

From: Lee Washington, 2015 Planning Commission Chairman
Date: December 22, 2015

Re: Conditional Use Permit request to allow a MF-1 density in an R-2A Zone at property located at 1919 and 1921 Clifton Street

A request for a Conditional Use Permit to allow MF-1 Density in an R-2A zoning district for property located at 1919 and 1921 Clifton Street with the legal descriptions:

[1919 Clifton Street]

PT LOT 200-E FIDDLERS SURVEY N 81 FT

and

[1921 Clifton Street]

PT LOT 200-E FIDDLERS SURVEY S 100 FT 100 FT X 587 FT

was reviewed by the Planning Commission at its regular meeting on December 21, 2015. The Planning Commission voted 6-0 that this request be forwarded to the City Council with a recommendation for approval subject to the below conditions.

Condition:

1. Planning Department development review is required. Particularly, drainage approval by the City Engineering Department.
2. Platting of the property is required. Platting will include additional street right of way as required.
3. The development is limited to a maximum of 28 units.
4. A 6-foot privacy fence is required along the south property line.
5. A 20-foot wide (or Fire Department approved width) private drive with approved fire apparatus turn-around will serve the development. The City will not maintain the private drive. On street parking is not allowed.
6. Setbacks as shown on the submitted site plan shall be allowed.
7. Sidewalks are required on both sides of the private street. Due to reduced setbacks, the sidewalk may be placed at back of curb.

Please advise if you have any questions.

CITY OF CONWAY

ALLEN SHAVER -- CONDITIONAL USE

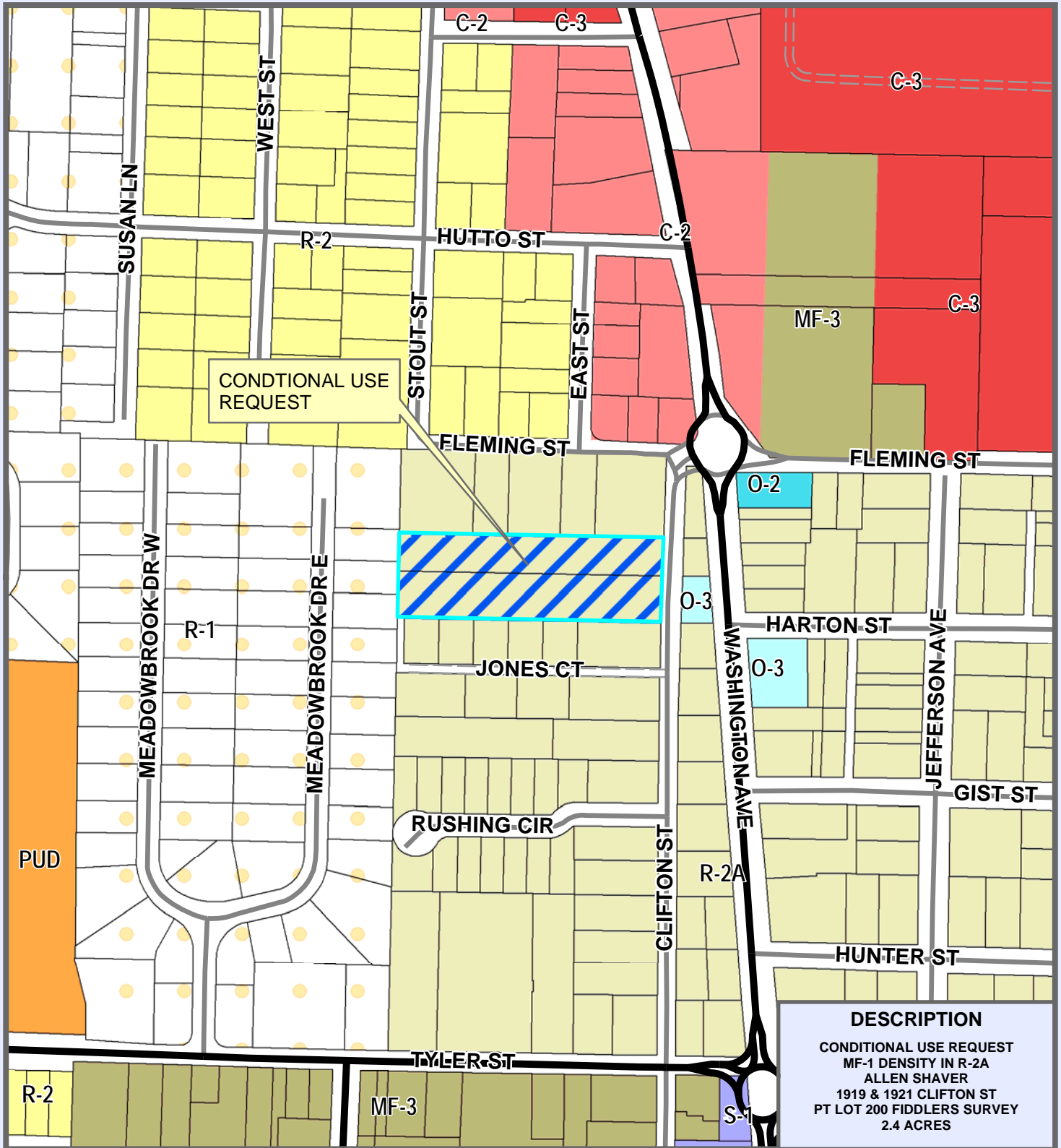

DESCRIPTION
CONDITIONAL USE REQUEST
MF-1 DENSITY IN R-2A
ALLEN SHAVER
1919 & 1921 CLIFTON ST
PT LOT 200 FIDDLERS SURVEY
2.4 ACRES

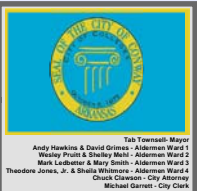

INTERSTATE	LOT LINE	Residential R-1	Industrial I-1
MAJOR ARTERIAL	STREAMS	Residential R-2A	Industrial MF-2
MINOR ARTERIAL	LAKES & PONDS	Residential R-2	Industrial MF-3
COLLECTOR	CITY LIMITS	Residential HR	Industrial RMH
RESIDENTIAL		Residential SR	Special SP
PRIVATE ROAD		Commercial C-1	Special S-1
INTERSTATE RAMP		Commercial C-2	Special A-1
RAILROADS		Commercial C-3	Special O-2
		Commercial C-4	Special O-3
			Special PUD
			Special TJ

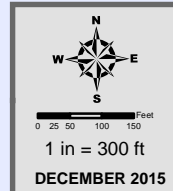

THIS MAP WAS PREPARED BY THE CITY OF CONWAY PLANNING AND DEVELOPMENT DEPARTMENT FOR ITS USE AND MAY BE REVISED AT ANY TIME WITHOUT NOTIFICATION TO ANY USER. THE CITY OF CONWAY PLANNING AND DEVELOPMENT DEPARTMENT DOES NOT GUARANTEE THE CORRECTNESS OR ACCURACY OF ANY FEATURES ON THIS MAP. CITY OF CONWAY ASSUMES NO RESPONSIBILITY IN CONNECTION THEREWITH.

CONTACT INFORMATION
 WWW.CONWAYPLANNING.ORG/GIS
 E-MAIL: Jason.Lyon@CityOfConway.org

Printing Date: 12/14/2015
 File: C:\GIS\Map\Planning Commission\2015\15DEC\ALLEN SHAVER USSE.mxd
 Printed By: jlyon



CONWAY PLANNING COMMISSION

1201 OAK STREET CONWAY, AR 72032 (501) 450-6105

MEMO

To: Mayor Tab Townsell
CC: City Council Members

From: Lee Washington, 2015 Planning Commission Chairman
Date: December 22, 2015

Re: Conditional Use Permit request to allow a Shelter for the Homeless in an RMH Zone at property located at 450 E. Robins, #21

A request for a conditional use permit to allow a Shelter for the Homeless at property located at 450 E. Robins Street, #21 with the legal description:

Beginning at the SW corner of the SE 1/4, SE 1/4, SW 1/4, T5N R13W, Section 7 at the centerline of a private drive; thence east approximately 112 feet; thence north approximately 16 feet to the point of beginning; thence east approximately 100 feet; thence north approximately 238 feet; thence west approximately 100 feet; thence south approximately 238 feet to the point of beginning. Said property being a part of Lot 6, C.H. Robinette property as shown on B.G. Wilson's Map of Conway dated 6-26-1917. Containing .55 acres +/-.

was reviewed by the Planning Commission at its regular meeting on December 21, 2015. The Planning Commission voted 7-0 that this request be forwarded to the City Council with a recommendation for approval subject to the below conditions.

Condition:

1. Conditional Use Permit is limited to applicant, Patricia Meeks/Last Chance Ministries.

Please advise if you have any questions.

CITY OF CONWAY

LAST CHANCE MINISTRIES -- CONDITIONAL USE

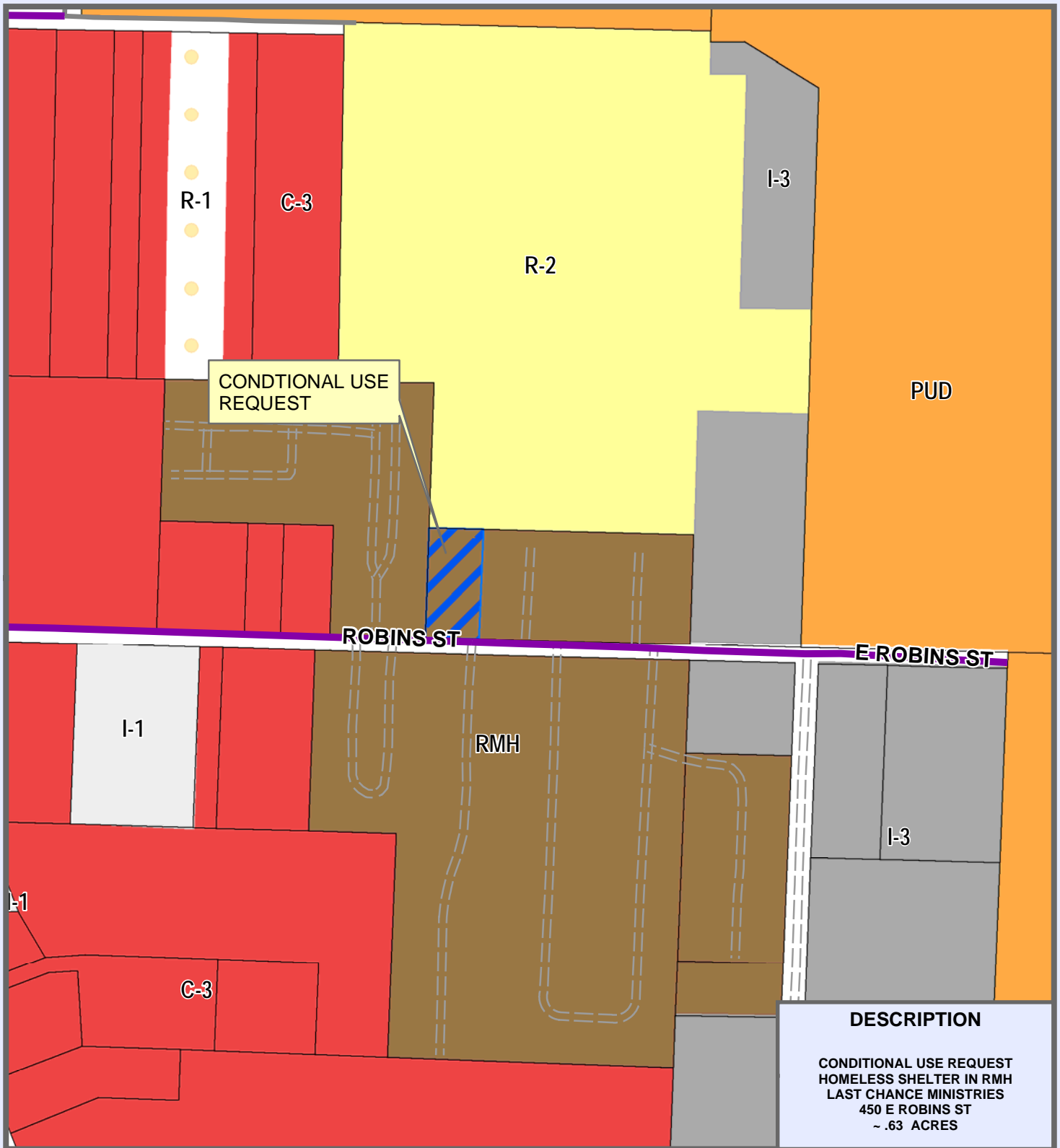

DESCRIPTION

**CONDITIONAL USE REQUEST
HOMELESS SHELTER IN RMH
LAST CHANCE MINISTRIES
450 E ROBINS ST
~ .63 ACRES**

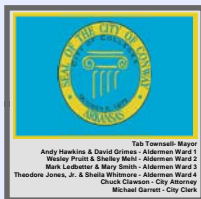

INTERSTATE	LOT LINE	Residential	Industrial
MAJOR ARTERIAL	STREAMS	R-1	I-1
MINOR ARTERIAL	LAKES & PONDS	R-2A	RU-1
COLLECTOR	CITY LIMITS	R-2	MF-3
RESIDENTIAL		HR	RMH
PRIVATE ROAD		SR	
INTERSTATE RAMP		Commercial Office	Special
RAILROADS		C-1	SP
		C-2	S-1
		C-3	A-1
		C-4	PUD
			TJ



THIS MAP WAS PREPARED BY THE CITY OF CONWAY PLANNING AND DEVELOPMENT DEPARTMENT FOR ITS USE, AND MAY BE REVISED AT ANY TIME WITHOUT NOTIFICATION TO ANY USER. THE CITY OF CONWAY PLANNING AND DEVELOPMENT DEPARTMENT DOES NOT GUARANTEE THE CORRECTNESS OR ACCURACY OF ANY FEATURES ON THIS MAP. CITY OF CONWAY ASSUMES NO RESPONSIBILITY IN CONNECTION THEREWITH.

CONTACT INFORMATION:
 WWW.CONWAYPLANNING.ORG/GIS
 E-MAIL: Jason.Lyon@CityOfConway.org



CITY OF CONWAY
Planning and Development

1201 Oak Street
Conway, AR 72032

T 501.450.6105
F 501.450.6144

www.conwayplanning.org

MEMO

December 30, 2015

To: Mayor and City Council

From: Bryan Patrick, Director of Planning and Development

In November 2015, Matt Bell with MFB Investments came before the Planning Commission and City Council requesting a conditional use permit to operate clinical treatment services at the Phoenix Recovery Center on Jersey Street.

City Council approved the conditional use permit with a condition requiring a one year Council review in November 2015. A new office and treatment facility is under construction. The degree of treatment services being offered at this time is unclear.

PERMIT **№ 1348**

USE2014NOV01
51306SW

CONDITIONAL USE PERMIT CITY OF CONWAY, ARKANSAS

PROPERTY DESCRIPTION / ADDRESS / LOCATION:

This conditional use is for property located 1222-1224, 1223-1225, and 1227-1229 Jersey Street with the following legal description:

Lots 5 and 6, Block 8, Browns Subdivision; Lot 18, Block 6, Browns Subdivision

ZONING: T-4 Transitional in the NEOCA Specific Plan

CONDITIONAL USE PERMITTED TO MFB INVESTMENTS, LLC FOR: Clinic Treatment Services

DATE OF COUNCIL MEETING ALLOWING PERMITTED USE: November 25, 2014

CONDITIONS ATTACHED TO PERMIT:

1. Hours of operation will not be limited.
2. Conditional Use Permit is limited to the applicant, MFB Investments, LLC (Phoenix Recovery)
3. The conditional user permit is valid for one (1) year. Applicant must appear before the Conway City Council in November 2015 for review.
4. Counseling treatment services may not be offered to violent offenders and sex offenders.

APPROVED:



Tab Townsell, Mayor

12/3/14

Date

AGREEMENT

WHEREAS, the City of Conway (the “Grantor”) executed a Pipeline Right of Way, Surface Site Easement, and Access Road Grant (the “ROW Agreement”) through which Grantor conveyed to Enable Gas Transmission, LLC (the “Grantee”) certain rights concerning real property in Faulkner County, Arkansas, which was filed and recorded on October 28, 2014 at 08:45:459 a.m as Doc#2014-15699 in the Official Records of Faulkner County;

WHEREAS, by the terms of the ROW Agreement, the Grantor conveyed to the Grantee a Surface Site Easement on real property more particularly described as follows:

COMMENCING at the Southeast corner of the Southwest $\frac{1}{4}$ of Section 32, Township 6 North, Range 14 West, Faulkner County, Arkansas and run North, a distance of 2,803.45 feet to a point;

THENCE, run East, a distance of 861.59 feet to the POINT OF BEGINNING, said point being the Southernmost corner of said Proposed Site; THENCE, run N $58^{\circ}26'19''$ W, a distance of 100 feet to a point; THENCE, run N $31^{\circ}33'41''$ W, a distance of 100 feet to a point; THENCE, run S $58^{\circ}26'19''$ E, a distance of 100 feet to a point; THENCE, run S $31^{\circ}33'41''$ W, a distance of 100 feet and back to the POINT OF BEGINNING.

Proposed Site: Contains 0.23 acres and lies entirely within and is a part of the Northeast $\frac{1}{4}$, the Southeast $\frac{1}{4}$ and the Northeast $\frac{1}{4}$ of the Southwest $\frac{1}{4}$ of Section 32, Township 6 North, Range 14 West, Faulkner County, Arkansas.

(“Surface Site Easement #1);

WHEREAS, Grantee has determined it necessary to relocate the Surface Site Facilities constructed on the Surface Site Easement #1;

WHEREAS, in order to accommodate such relocation of the Surface Site Facilities, the Grantor and the Grantee have executed an Amended Pipeline Right of Way, Surface Site Easement, and Access Road Grant (the “Amended ROW Agreement”) whereby the Grantee will construct additional Surface Site Facilities on real property more particularly described as follows:

COMMENCING at the Southeast corner of the Southwest $\frac{1}{4}$ of Section 32, Township 6 North, Range 14 West, Faulkner County, Arkansas and run North, a distance of 1,944.71 feet to a point;

THENCE, run East, a distance of 323.64 feet to the POINT OF BEGINNING, said point being the Eastern most point of the Proposed Site; THENCE, run S $48^{\circ}38'09''$ W, a distance of 125.00 feet to a point; THENCE, run N $88^{\circ}11'21''$ W, a distance of 143.67 feet to a point; THENCE, run N $48^{\circ}38'09''$ E, a distance of 229.77 feet to a point; THENCE, run S $41^{\circ}21'51''$ E, a distance of 98.30 feet to the POINT OF BEGINNING.

Proposed Site: Contains 0.40 acres and lies entirely within and is a part of the Northeast ¼, the Southeast ¼ and the Northeast ¼ of the Southwest ¼ of Section 32, Township 6 North, Range 14 West, Faulkner County, Arkansas.

(“Surface Site Easement #2”); and

WHEREAS, the Grantor acknowledges and agrees that Grantee must remove the Surface Site Facilities constructed on Surface Site Easement #1, and that Grantee must have a sufficient amount of time in which to remove such facilities.

WHEREFORE, THE GRANTOR AGREES THAT:

- A) For a period of six (6) months following the filing and recording of the Amended ROW Agreement, Grantee shall retain all rights granted to it under the initial ROW Agreement regarding Surface Site Easement #1, such retention of rights being necessary for the purpose of permitting Grantee to remove the Surface Site Facilities located on Surface Site Easement #1.

Grantor:
City of Conway, Arkansas

By: Tab Townsell
Title: Mayor

This instrument was prepared by Enable Gas Transmission, LLC
P.O. Box 21734, Shreveport, LA

**AMENDED PIPELINE RIGHT OF WAY, SURFACE SITE EASEMENT AND
ACCESS ROAD GRANT**

KNOW ALL MEN BY THESE PRESENTS: that the undersigned **City of Conway, Arkansas**, whose address is **1201 Oak Street, Conway, AR 72032** (hereinafter “Grantor” whether one or more), for and in consideration of the sum of Ten and 00/100 Dollars (\$10.00) and other valuable consideration paid by **Enable Gas Transmission, LLC**, a Delaware limited liability company whose address is P. O. Box 21734, Shreveport, Louisiana, 71151 (hereinafter “Grantee” or “CEGT”), the receipt and sufficiency of which are hereby acknowledged, does hereby grant, sell, warrant and convey unto Grantee, its successors and assigns, a permanent, right of way and easement (hereinafter “Pipeline Right of Way”) Fifty feet (50’) in width, for the purpose of constructing, laying, installing, maintaining, protecting, marking, operating, inspecting, altering, repairing, upgrading, replacing, removing, reconstructing, relocating, changing the size of, and removing two or more pipelines, from time to time, and any and all necessary or useful appurtenances thereto, including vent pipes, corrosion control monitoring equipment, pipeline markers and any other above ground appurtenant facilities as may be required to meet federal, state and local regulations (hereinafter “Pipeline Facilities”), all of which shall be and remain the property of Grantee, for the transportation of oil or gas and all by-products thereof or any liquids, gases or substances which can be transported through pipelines, under, upon, over and through lands which Grantor owns or in which Grantor has an interest, situated in the **County of Faulkner, State of Arkansas** (hereinafter “Grantor’s Lands” or “Property”), more particularly described as follows:

CENTERLINE DESCRIPTION FOR A PROPOSED 50’ WIDE PERMANENT RIGHT OF WAY & EASEMENT, DESCRIPTION FOR A PROPOSED TEMPORARY RIGHT OF WAY, DESCRIPTION OF PROPOSED EXTRA TEMPORARY WORK SPACE AND DESCRIPTION OF A PROPOSED SITE, ACROSS THE PROPERTY OF THE CITY OF CONWAY.

Centerline Description of a Proposed Fifty foot (50’) wide Permanent Right of Way & Easement, Description for a Proposed Temporary Right of Way, Description of Proposed Extra Temporary Work Space and Description of a Proposed Site, extending over, through, along and across a tract of land lying within and being a part of the Northeast ¼, the Southeast ¼ and the Northeast ¼ of the Southwest ¼ of Section 32, Township 6 North, Range 14 West, Faulkner County, Arkansas as recorded in Book 430, Page 375, with the Office of the Clerk and Recorder of

Faulkner County, Arkansas, the side lines of said Fifty foot (50') wide Permanent Right of Way & Easement being lengthened or shortened to meet the Northern boundary of the aforesaid Proposed Site, all being more particularly described as follows:

Bearings are based off of a GPS observation transformed into NAD 83, Arkansas South Grid Datum.

BT-14 PROPOSED PERMANENT RIGHT OF WAY AND EASEMENT

Centerline description for a proposed Fifty foot (50') wide Permanent Right of Way & Easement:

COMMENCING at the Southeast corner of the Southwest ¼ of Section 32, Township 6 North, Range 14 West, Faulkner Count, Arkansas and run North, a distance of 2,795.13 feet to a point; THENCE, run East, a distance of 840.33 feet to the POINT OF BEGINNING, said point lying on Exiting BT-14 Pipeline; THENCE, run S 77°01'34" W, a distance of 71.50 feet to a point; THENCE, run S32°01'34"W, a distance of 925.49 feet to the POINT OF TERMINATION, said point lying on the Northeast boundary of the aforesaid Proposed Site, being 1,994.44 feet North and 279.86 feet East of said Southeast corner of the Southwest ¼.

Proposed Permanent Easement: Contains 1.44 acres and lies entirely within and is a part of the Northeast ¼, the Southeast ¼ and the Northeast ¼ of the Southwest ¼ of Section 32, Township 6 North, Range 14 West, Faulkner County, Arkansas.

PROPOSED TEMPORARY RIGHT OF WAY AND PROPOSED EXTRA TEMPORARY WORK SPACE

COMMENCING at the Southeast corner of the Southwest ¼ of Section 32, Township 6 North, Range 14 West, Faulkner County, Arkansas and run North, a distance of 2,795.13 feet to a point; THENCE, run East, a distance of 840.33 feet to the POINT OF BEGINNING, said point lying on Exiting BT-14 Pipeline; THENCE, run N12°58'26"W, a distance of 25.00 feet to a point; THENCE, run S77°01'34"W, a distance of 81.86 feet to a point; THENCE, run S32°01'34"W, a distance of 928.39 feet to a point; THENCE, run N41°21'51"W, a distance of 5.96 feet to a point; THENCE, run S48°38'09"W, a distance of 229.77 feet to a point; THENCE, run S88°11'21"E, a distance of 140.20 feet to a point; THENCE, run S65°40'03"E, a distance of 30.04 feet to a point; THENCE, run S48°38'09"W, a distance of 19.73 feet to a point; THENCE, run N88°11'21"W, a distance of 178.56 feet to a point; THENCE, run N01°48'40"E, a distance of 35.83 feet to a point; THENCE, run N48°38'09"E, a distance of 256.92 feet to a point; THENCE, run N32°01'34"E, a distance of 914.25 feet to a point; THENCE, run N77°01'34"E, a distance of 142.24 feet to a point; THENCE, run S12°58'26"E, a distance of 125.00 feet to a point; THENCE, run S77°01'34"W, a distance of 161.15 feet to a point; THENCE, run N32°01'34"E, a distance of 70.71 feet to a point; THENCE, run N77°01'34"E, a distance of 61.15 feet to a point; THENCE, run N12°58'26"W, a distance of 25.00 feet to the POINT OF BEGINNING, AND COMMENCING at the Southeast corner of the Southwest ¼ of Section 32, Township 6 North, Range 14 West, Faulkner County, Arkansas and run North, a distance of

1,944.71 feet to a point; THENCE, run East, a distance of 323.64 feet to the POINT OF BEGINNING, said point being the Eastern most point of the Proposed Site; THENCE, run N41°21'51"E, a distance of 40.17 feet to a point; THENCE, run N32°01'34"E, a distance of 26.09 feet to a point; THENCE, run S41°21'51"W, a distance of 76.63 feet to a point; THENCE, run S48°38'09"W, a distance of 107.25 feet to a point; THENCE, run N65°40'03"W, a distance of 27.43 feet to a point; THENCE, run N48°38'09"E, a distance of 93.54 feet to the POINT OF BEGINNING.

Proposed Temporary Right of Way and Proposed Extra Temporary Work Space: Contains 1.16 acres and lies entirely within and is a part of the Northeast ¼, the Southeast ¼ and the Northeast ¼ of the Southwest ¼ of Section 32, Township 6 North, Range 14 West, Faulkner County, Arkansas.

BT-39 CENTERLINE DESCRIPTION OF A 40' WIDE PERMANENT RIGHT OF WAY & EASEMENT, ACROSS THE PROPERTY OF THE CITY OF CONWAY.

Centerline Description of a Forty foot (40') wide Permanent Right of Way & Easement, extending over, through, along and across a tract of land lying within and being a part of the Northeast ¼, the Southeast ¼ and the Northeast ¼ of the Southwest ¼ of Section 32, Township 6 North, Range 14 West, Faulkner County, Arkansas as recorded in Book 430, Page 375, with the Office of the Clerk and Recorder of Faulkner County, Arkansas, the side lines of said Forty foot (40') wide Permanent Right of Way & Easement being lengthened or shortened to meet the Northern boundary of the aforesaid Proposed Site, all being more particularly described as follows:

Bearings are based off of a GPS observation transformed into NAD 83, Arkansas South Grid Datum.

COMMENCING at the Southeast corner of the Southwest ¼ of Section 32, Township 6 North, Range 14 West, Faulkner Count, Arkansas and run North, a distance of 1,865.46 feet to a point; THENCE, run East, a distance of 123.55 feet to the POINT OF BEGINNING, said point lying on the South boundary of the above described Proposed Site; THENCE, run S 48°26'51" W, a distance of 310.58 feet to a point;
Page 3 of 3

THENCE, run S01°43'59"E, a distance of 37.41 feet to the POINT OF TERMINATION, said point lying on the South boundary of the aforesaid tract, being common with the North right of way line of Union Pacific Railroad, said point being 1,622.06 feet North and 107.74 feet West of said Southeast corner of the Southwest ¼.

Permanent Easement: Contains 0.32 acres and lies entirely within and is a part of the Northeast ¼, the Southeast ¼ and the Northeast ¼ of the Southwest ¼ of Section 32, Township 6 North, Range 14 West, Faulkner County, Arkansas.

If more than one pipeline is constructed pursuant to this Agreement, the same consideration shall be paid for each additional line as was paid for the initial line installed in addition to any damages arising therefrom.

Subject to the provisions of this Grant and provided such use does not interfere with or

adversely affect the use and rights of Grantee, Grantor shall have the right to use the Permanent Right of Way and Temporary Workspace. Further, Grantee shall have the right to remove, clear and to keep clear, without liability for damages, all buildings, structures, walls, pipes, conduits, equipment, trees, plants, undergrowth, brush and any other structures, works, growth or obstructions in or on the Permanent Right of Way which might interfere with or adversely affect the use of the Permanent Right of Way or operation or integrity of the Pipeline Facilities. Further, Grantor shall not, nor shall Grantor allow any third party to, (i) construct any temporary or permanent structure, work or obstruction above or below ground on the Permanent Right of Way, (ii) remove soil from, change the grade or slope of, excavate, fill or impound water on the Pipeline Permanent Right of Way, or (iii) interfere with the vegetative maintenance activities deemed necessary by Grantee. Grantor hereby expressly retains and reserves unto itself, its successors and assigns, the right to fully use, occupy and enjoy the lands burdened by this easement for any purpose whatsoever, so long as such use and occupancy does not prevent Grantee from exercising the rights granted it hereunder. Grantor, its successors and assigns, may grant the right to construct above ground and below ground utilities on, over and across the Permanent Right-of-Way, provided such use does not unreasonably interfere with or adversely affect the use and rights of Grantee. Grantor will give Grantee written notice as soon as possible, but not less than ten (10) days prior to the construction of any above or below ground utilities on the Permanent Right-of-Way addressed to the Grantee as follows:

Enable Gas Transmission, LLC
Right of Way Department
525 Milam Street
Shreveport, LA 71001

Grantee shall have the right to use the Permanent Right of Way and Temporary Workspace. Further, Grantee shall have the right to remove, clear and to keep clear all unpermitted improvements as well as all trees, plants, undergrowth, brush and other obstructions in or on the Permanent Right of Way which might interfere with or adversely affect the use of the Permanent Right of Way or operation or integrity of the Pipeline Facilities. Further, neither Grantor or Grantee shall, nor shall Grantor or Grantee allow any third party to, (i) construct any temporary or permanent structure above ground on the Permanent Right of Way, except as set out in the terms of the Grant, (ii) remove soil from, change the grade or slope of, excavate, fill or impound water on the Permanent Right of Way, or (iii) interfere with the vegetative maintenance activities deemed necessary by Grantor or Grantee.

Grantor hereby expressly retains and reserves unto itself, its successors and assigns, the right to fully use, occupy and enjoy the lands burdened by the pipeline easement for any purpose whatsoever, so long as such use and occupancy does not prevent Grantee from exercising the rights granted it hereunder. Grantor acknowledges that construction of a permanent building or dwelling on the burdened lands would infringe on Grantee's rights under this instrument and, accordingly, is not permitted.

The Pipeline Right of Way is depicted on the plat designated as Exhibit's A & D attached hereto and made a part hereof.

Grantor also grants and conveys to Grantee, its successors and assigns, a temporary easement for use as temporary work space (hereinafter "Pipeline Temporary Workspace") adjacent to one or both sides of the Pipeline Right of Way to facilitate the construction of the Pipeline Facilities which is generally shown on the attached plat. In addition, the Pipeline Temporary Workspace shall include the area along the Pipeline Right of Way at certain crossings, including, without limitation, crossings of roads, pipelines, utilities, railroads, streams, ditches, terraces, uneven terrain, and horizontal direction drills, as generally depicted on the attached plat during the time of installation and construction. The Pipeline Temporary Workspace is depicted on Exhibit's A & D.

Grantor, for the same consideration, further grants, sells, conveys, warrants and delivers to Grantee, its successors and assigns, a surface easement and right of way with a perimeter of approximately 125 feet on the southwest, 144 feet on the northwest, 230 feet on the northeast, and 98 feet on the southeast(the "Surface Site Easement "), to install, construct, maintain, operate, inspect, repair, alter, protect, fence, mark, change the size of, replace, relocate and remove natural gas metering and regulating facilities (the "Surface Site Facilities") and any and all appliances, appurtenances, fixtures and equipment related thereto (the "Surface Site Equipment"), whether above or below ground, including, but not limited to, meters, regulators, separators, heaters, pipelines, tie-overs, headers, valves, blow offs, fittings and the housings for same, tanks, fences, structures, electric lines, communication lines and related equipment, as well as launcher and receiver equipment, from time to time deemed by Grantee to be necessary or desirable in connection with or incidental to the conduct of Grantee's business, upon, over, under, through and across the Property, and more particularly described as follows:

COMMENCING at the Southeast corner of the Southwest ¼ of Section 32, Township 6 North, Range 14 West, Faulkner County, Arkansas and run North, a distance of 1,944.71 feet to a point; THENCE, run East, a distance of 323.64 feet to the POINT OF BEGINNING, said point being the Eastern most point of the Proposed Site; THENCE, run S48°38'09"W, a distance of 125.00 feet to a point; THENCE, run N88°11'21"W, a distance of 143.67 feet to a point; THENCE, run N48°38'09"E, a distance of 229.77 feet to a point; THENCE, run S41°21'51"E, a distance of 98.30 feet to the POINT OF BEGINNING.

Proposed Site: Contains 0.40 acres and lies entirely within and is a part of the Northeast ¼, the Southeast ¼ and the Northeast ¼ of the Southwest ¼ of Section 32, Township 6 North, Range 14 West, Faulkner County, Arkansas.

The Surface Site Easement is depicted on Exhibit's B & D.

Grantee, its successors and assigns, shall have exclusive use of the Surface Site Easement. Grantor shall not build, create or construct, nor allow to be built, created or constructed, any obstruction including, but not limited to, impounded water, buildings, improvements or other structures within the Surface Site Easement , nor shall Grantor place, nor allow to be placed, any debris on the Surface Site Easement. Grantee shall have the right to

periodically clear and keep the Surface Site Easement cleared of trees, shrubs, brush or other debris.

Grantor, for the same consideration, further grants, sells, conveys, warrants and delivers to Grantee, its successors and assigns, in connection with the construction, operation, maintenance or use of the Pipeline Facilities on the Pipeline Right of Way and the Surface Site Facilities on the Surface Site Easement, an easement and right of way Twenty feet (20') in width, for the construction, maintenance and use of an access road (the "Access Road") and utilities (the "Access Road Easement"), upon, over, under, through and across the Property, from the southern boundary of the Property to and within the Pipeline Right of Way and Surface Site Easement, which is more specifically described as follows:

A part of the NE/4, part of the SE/4, and part of the NE/4 SW/4 of Section 32, Township 6 North, Range 14 West, being a part of the property described in deed recorded in Book 430, Page 375, of the Deed Records of said County, to which reference is here made for further description.

The Access Road and the Access Road Easement are depicted on Exhibit's B and C.

To Have and to Hold the rights granted herein unto Grantee, its successors and assigns. Grantor represents and warrants that Grantor is owner of the Property, and Grantor does hereby bind Grantor, its heirs, legal representatives, successors and assigns, to warrant Grantor's Lands and the rights granted Grantee, its successors and assigns, against every person whomsoever lawfully claiming or to claim the same or any part thereof and that Grantor has authority to convey the rights and interests referred to herein to Grantee.

The rights granted herein shall also extend to and include the free and full right of reasonable ingress and egress over and across Grantor's Land and other adjacent lands owned or leased by Grantor to and from the easements for Grantee's exercise at any time, and from time to time, of the rights granted herein. To the extent Grantee determines it practicable, such ingress and egress should be over such roads or ways as may exist at the time of each particular exercise of Grantor's rights hereunder.

Grantor and Grantee agree that the above mentioned consideration includes payment for all damages for the construction of the Pipeline Facilities, the Access Road and the Surface Site Facilities including any severance damages to Grantor's Land, including payment for all damages to growing crops, cultivated land, pasturage, trees, plants, fences, drains, structures or buildings of Grantor or of any lessee, tenant or contractor of Grantor, located within the Permanent Right-of-Way and Temporary Workspace, the Access Road Easement and the Surface Site Easement, resulting from the exercise of the rights herein granted and conveyed to Grantee. However, nothing herein shall relieve Grantee from any liability or obligation to pay for damages to any utilities, whether on or off the Permanent Right-of-Way and Temporary Workspace, the Access Road Easement and the Surface Site Easement caused by the

construction or maintenance of the Pipeline Facilities, the Access Road or the Surface Site Facilities. Upon receipt of payment of the consideration referred to herein Grantor releases and agrees to indemnify to the extent permitted under law Grantee for or from damages of Grantor or any lessee, tenant or contractor of Grantor except as provided above.

The rights, title and privileges herein granted may, in whole or in part, be sold, leased, assigned, pledged, and mortgaged, and shall be binding upon and inure to the benefit of the parties hereto, their respective heirs, legatees, legal representatives, successors and assigns. Grantor agrees to execute such other documents as may be reasonably necessary or desirable to give full effect to the intent of the parties hereto and to refrain from any action that is inconsistent with those rights being conveyed to Grantee. The failure of Grantee to exercise any rights herein conveyed shall not be considered a waiver of such rights and shall not bar Grantee from exercising any such rights in the future, or if necessary, seeking an appropriate remedy in conjunction with such rights. Grantor understands and agrees that the person securing this grant is without authority from Grantee to make any agreement with respect to any subject matter not herein expressed and the provisions of this Agreement represents the entire agreement between the parties. This instrument may be executed in any number of counterparts, each of which shall be deemed an original, but all of which together shall constitute one and the same instrument.

This Amended Pipeline Right of Way, Surface Site Easement and Access Road Grant shall supersede and replace the Pipeline Right of Way, Surface Site Easement and Access Road Grant filed and recorded in the Official Records of Faulkner County, Arkansas on 10/28/2014 at 08:45:49 a.m. as Doc#2014-15699.

Executed on this _____ day of January, 2016.

Grantor:
City of Conway, Arkansas

By: Tab Townsell
Title: Mayor

Job#: 14832
I O #: 13072859

EXHIBIT "A"
SECTION 32, T6N, R14W
FAULKNER COUNTY, ARKANSAS

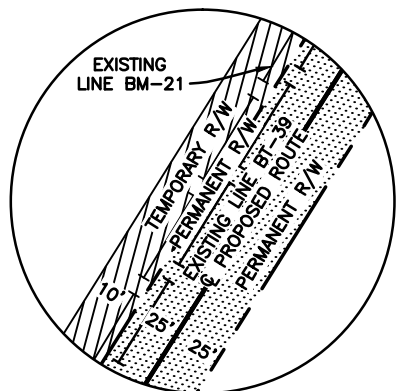
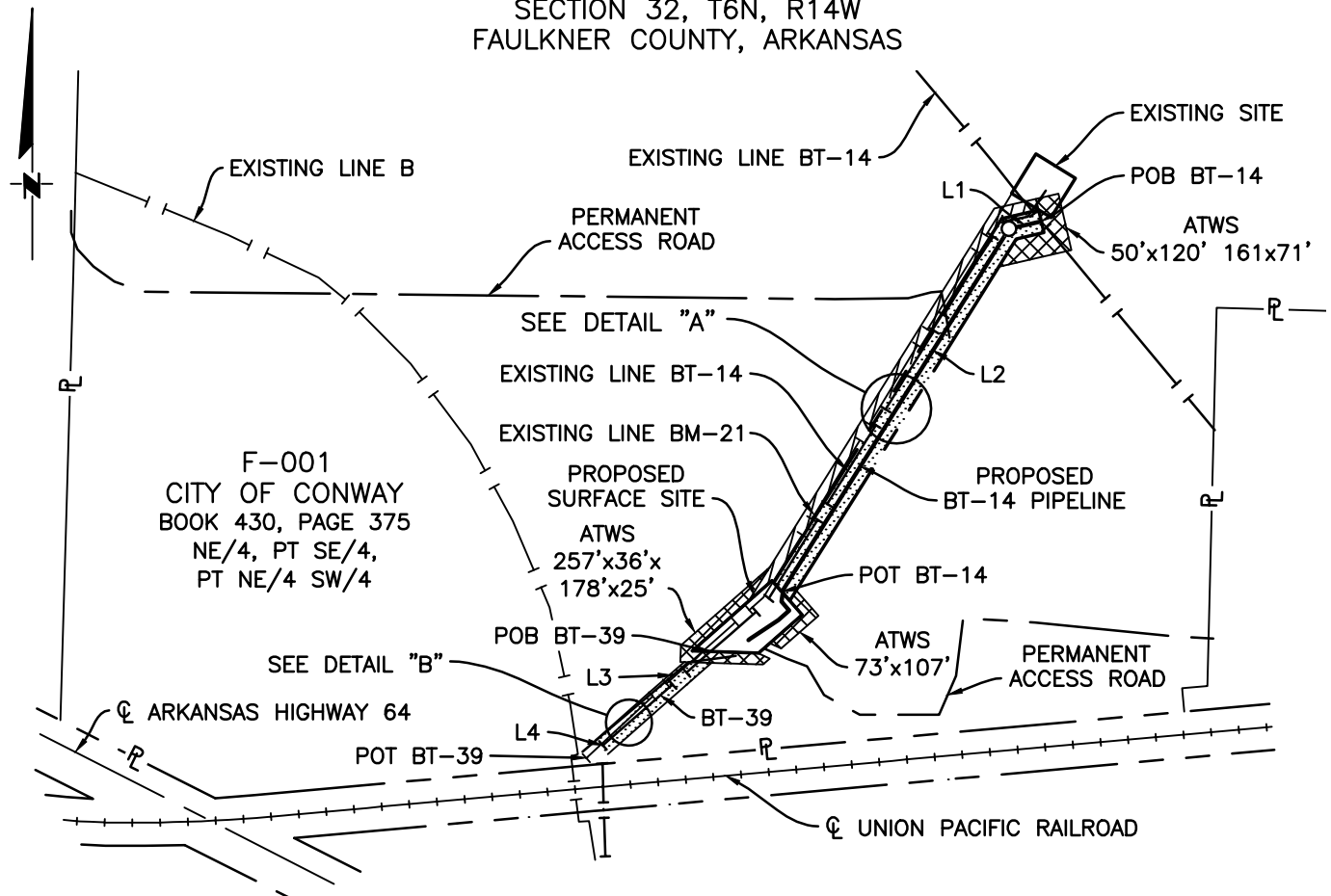

DETAIL "A"
N.T.S.

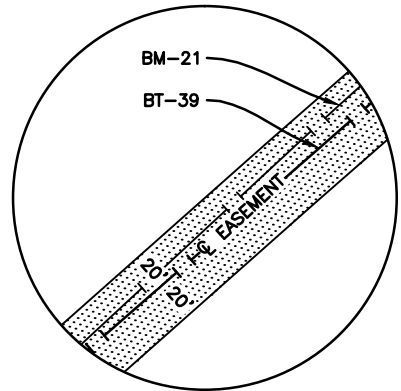

DETAIL "B"
N.T.S.

POB—POINT OF BEGINNING
 POT—POINT OF TERMINATION

POB FOR BT-14 IS NORTH, 2795.13' AND EAST, 840.33' OF THE SE/C OF THE SW 1/4 OF SECTION 32, T6N, R14W

POB FOR BT-39 IS NORTH, 1865.46' AND EAST, 123.55' OF THE SE/C OF THE SW 1/4 OF SECTION 32, T6N, R14W.

PROPERTY OF
 CITY OF CONWAY
 TRACT F-001
 996.99 FT. ~ 60.42 RODS

- PROPOSED PERMANENT RIGHT-OF-WAY = 1.14 ACRES
- PROPOSED TEMPORARY RIGHT-OF-WAY = 0.56 ACRES
- EXTRA TEMPORARY WORK SPACE = 0.63 ACRES

NOTE:
 THIS IS AN EASEMENT DRAWING AND DOES NOT REPRESENT A BOUNDARY SURVEY.

PROPOSED ROUTE		
COURSE	BEARING	DISTANCE
L1	S 77°01'34" W	72'
L2	S 32°01'34" W	925'
L3	S 48°26'51" W	311'
L4	S 01°43'59" E	37'

Enable Gas Transmission, LLC
 MIDSTREAM PARTNERS SHREVEPORT, LA

**PROPOSED 12" LINE BT-14 CROSSING THE
 PROPERTY OF CITY OF CONWAY
 FAULKNER COUNTY, ARKANSAS**

SCALE:	CREATED ON:	LAST EDIT DATE	DRAWN BY:	A PL	BT-14	001 A B
1" = 400'	12/09/15	12/09/15	HMM	SHT SIZE	JOB TYPE	JOB NUMBER
						DWG AREA
						SHEET AREA
						REF SHT
						R

EXHIBIT "B"
SECTION 32, T6N, R14W
FAULKNER COUNTY, ARKANSAS

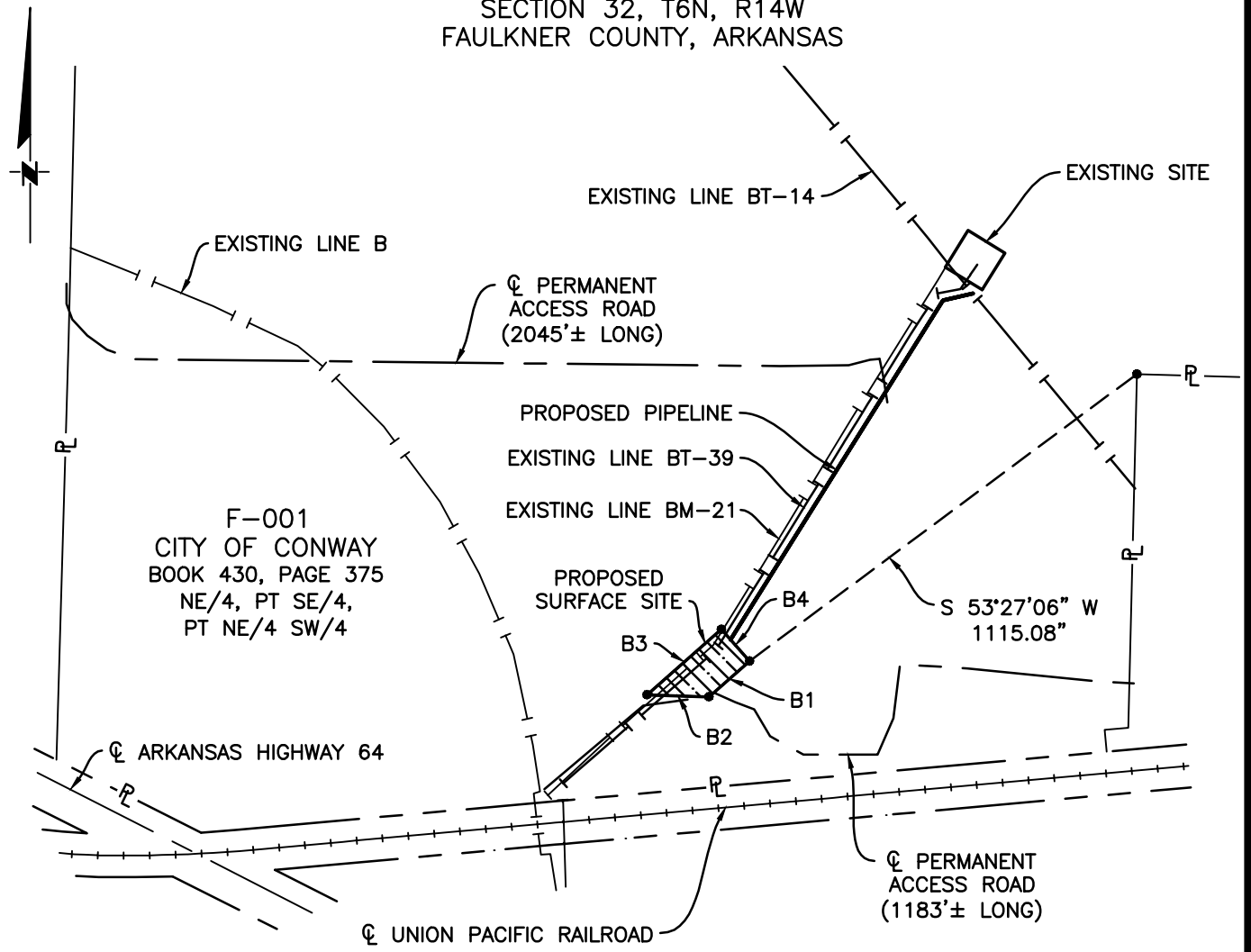

F-001
CITY OF CONWAY
BOOK 430, PAGE 375
NE/4, PT SE/4,
PT NE/4 SW/4

PROPOSED SITE BOUNDARY		
COURSE	BEARING	DISTANCE
B1	S 48°38'09" W	125'
B2	N 88°11'21" W	144'
B3	N 48°38'09" E	230'
B4	S 41°21'51" E	98'

PROPERTY OF
CITY OF CONWAY
TRACT F-001

PROPOSED SURFACE SITE = 0.40 ACRES

NOTE:
THIS IS AN EASEMENT DRAWING
AND DOES NOT REPRESENT A
BOUNDARY SURVEY.



Enable Gas Transmission, LLC
SHREVEPORT, LA

**PROPOSED SITE SITUATED ON THE
PROPERTY OF CITY OF CONWAY
FAULKNER COUNTY, ARKANSAS**

SCALE: 1" = 400'	CREATED ON: 10/21/15	LAST EDIT DATE: 10/21/15	DRAWN BY: HMM	A PL	BT-39	001ABA
			SHT SIZE	JOB TYPE	JOB NUMBER	DWG AREA SHEET/AREA REF SHT R

EXHIBIT "C"
 SECTIONS 32 & 33, T6N, R14W
 FAULKNER COUNTY, ARKANSAS

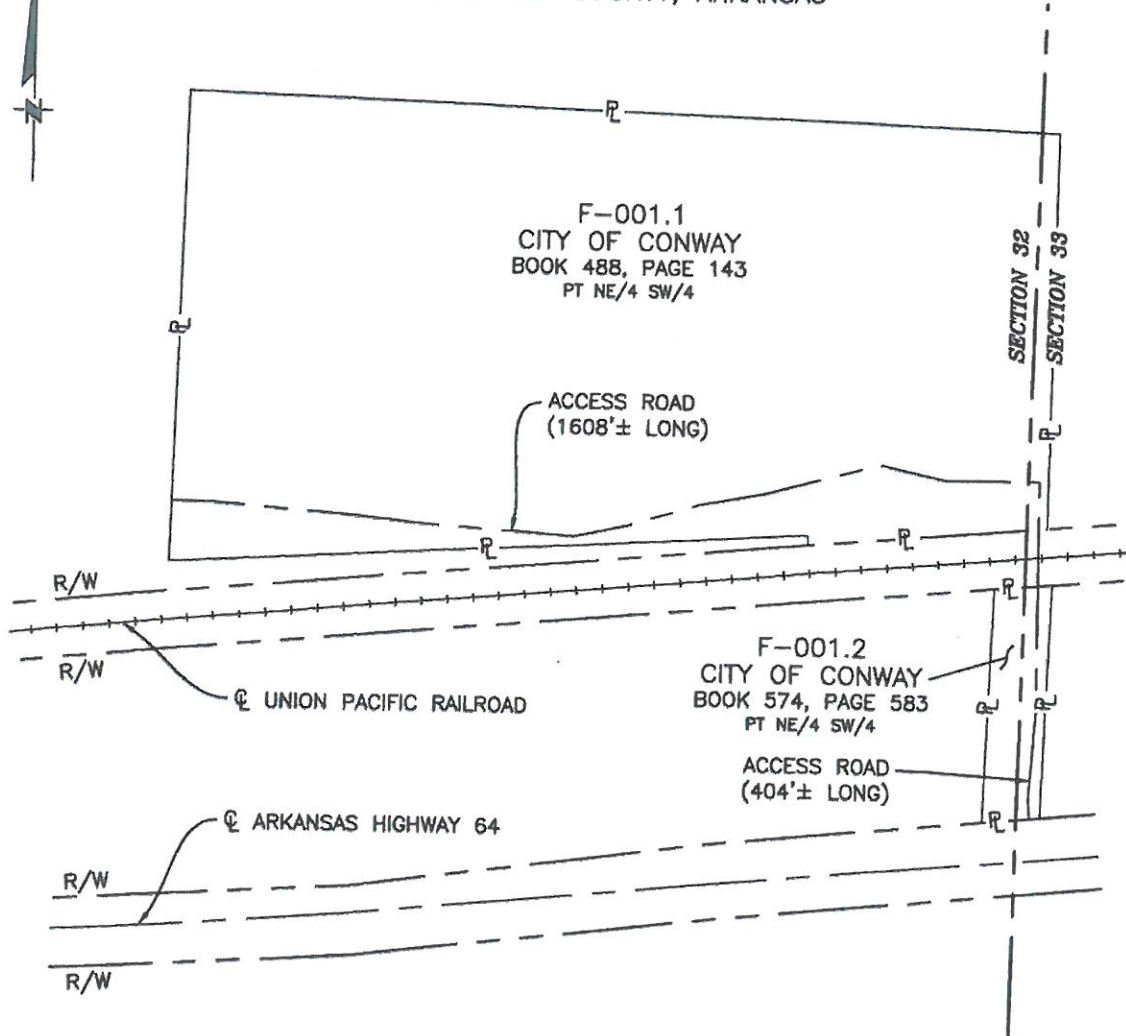

NOTE:
 THIS IS AN EASEMENT DRAWING
 AND DOES NOT REPRESENT A
 BOUNDARY SURVEY.

PROPERTY OF
 CITY OF CONWAY
 TRACTS F-001.1 & F-001.2

ENABLE **Enable Gas Transmission, LLC**
MIDSTREAM PARTNERS
 SHREVEPORT, LA

**PROPOSED ACCESS ROAD CROSSING THE
 PROPERTY OF CITY OF CONWAY
 FAULKNER COUNTY, ARKANSAS**

SCALE:	CREATED ON:	LAST EDIT DATE	DRAWN BY:	A PL	BT-39	001AB
1" = 300'	03/10/13	09/19/13	NJP	SHT SIZE	JOB NUMBER	DWG AREA
						SHEET/ AREA
						REF SHT
						R

Enable Gas Transmission, LLC

City of Conway

State of Arkansas

County of Faulkner

EXHIBIT "D"

TRACT F-001

BT-14

CENTERLINE DESCRIPTION FOR A PROPOSED 50' WIDE PERMANENT RIGHT OF WAY & EASEMENT, DESCRIPTION FOR A PROPOSED TEMPORARY RIGHT OF WAY, DESCRIPTION OF PROPOSED EXTRA TEMPORARY WORK SPACE AND DESCRIPTION OF A PROPOSED SITE, ACROSS THE PROPERTY OF THE CITY OF CONWAY.

Centerline Description of a Proposed Fifty foot (50') wide Permanent Right of Way & Easement, Description for a Proposed Temporary Right of Way, Description of Proposed Extra Temporary Work Space and Description of a Proposed Site, extending over, through, along and across a tract of land lying within and being a part of the Northeast ¼, the Southeast ¼ and the Northeast ¼ of the Southwest ¼ of Section 32, Township 6 North, Range 14 West, Faulkner County, Arkansas as recorded in Book 430, Page 375, with the Office of the Clerk and Recorder of Faulkner County, Arkansas, the side lines of said Fifty foot (50') wide Permanent Right of Way & Easement being lengthened or shortened to meet the Northern boundary of the aforesaid Proposed Site, all being more particularly described as follows:

Bearings are based off of a GPS observation transformed into NAD 83, Arkansas South Grid Datum.

PROPOSED PERMANENT RIGHT OF WAY AND EASEMENT

Centerline description for a proposed Fifty foot (50') wide Permanent Right of Way & Easement:

COMMENCING at the Southeast corner of the Southwest ¼ of Section 32, Township 6 North, Range 14 West, Faulkner Count, Arkansas and run North, a distance of 2,795.13 feet to a point;

THENCE, run East, a distance of 840.33 feet to the **POINT OF BEGINNING**, said point lying on Exiting BT-14 Pipeline;

THENCE, run S 77°01'34" W, a distance of 71.50 feet to a point;

THENCE, run S32°01'34"W, a distance of 925.49 feet to the **POINT OF TERMINATION**, said point lying on the Northeast boundary of the aforesaid Proposed Site, being 1,994.44 feet North and 279.86 feet East of said Southeast corner of the Southwest ¼.

Proposed Permanent Easement: Contains 1.14 acres and lies entirely within and is a part of the Northeast ¼, the Southeast ¼ and the Northeast ¼ of the Southwest ¼ of Section 32, Township 6 North, Range 14 West, Faulkner County, Arkansas.

PROPOSED TEMPORARY RIGHT OF WAY AND PROPOSED EXTRA TEMPORARY WORK SPACE

COMMENCING at the Southeast corner of the Southwest ¼ of Section 32, Township 6 North, Range 14 West, Faulkner County, Arkansas and run North, a distance of 2,795.13 feet to a point;

THENCE, run East, a distance of 840.33 feet to the **POINT OF BEGINNING**, said point lying on Exiting BT-14 Pipeline;

THENCE, run N12°58'26"W, a distance of 25.00 feet to a point;

THENCE, run S77°01'34"W, a distance of 81.86 feet to a point;

THENCE, run S32°01'34"W, a distance of 928.39 feet to a point;

THENCE, run N41°21'51"W, a distance of 5.96 feet to a point;

THENCE, run S48°38'09"W, a distance of 229.77 feet to a point;

THENCE, run S88°11'21"E, a distance of 140.20 feet to a point;

THENCE, run S65°40'03"E, a distance of 30.04 feet to a point;

THENCE, run S48°38'09"W, a distance of 19.73 feet to a point;

THENCE, run N88°11'21"W, a distance of 178.56 feet to a point;

THENCE, run N01°48'40"E, a distance of 35.83 feet to a point;

THENCE, run N48°38'09"E, a distance of 256.92 feet to a point;

THENCE, run N32°01'34"E, a distance of 914.25 feet to a point;

THENCE, run N77°01'34"E, a distance of 142.24 feet to a point;

THENCE, run S12°58'26"E, a distance of 125.00 feet to a point;

THENCE, run S77°01'34"W, a distance of 161.15 feet to a point;

THENCE, run N32°01'34"E, a distance of 70.71 feet to a point;

THENCE, run N77°01'34"E, a distance of 61.15 feet to a point;

THENCE, run N12°58'26"W, a distance of 25.00 feet to the **POINT OF BEGINNING, AND**

COMMENCING at the Southeast corner of the Southwest ¼ of Section 32, Township 6 North, Range 14 West, Faulkner County, Arkansas and run North, a distance of 1,944.71 feet to a point;

THENCE, run East, a distance of 323.64 feet to the **POINT OF BEGINNING**, said point being the Eastern most point of the Proposed Site;

THENCE, run N41°21'51"E, a distance of 40.17 feet to a point;

THENCE, run N32°01'34"E, a distance of 26.09 feet to a point;

THENCE, run S41°21'51"W, a distance of 76.63 feet to a point;

THENCE, run S48°38'09"W, a distance of 107.25 feet to a point;

THENCE, run N65°40'03"W, a distance of 27.43 feet to a point;

THENCE, run N48°38'09"E, a distance of 93.54 feet to the **POINT OF BEGINNING**,

Proposed Temporary Right of Way and Proposed Extra Temporary Work Space: Contains 1.16 acres and lies entirely within and is a part of the Northeast ¼, the Southeast ¼ and the Northeast ¼ of the Southwest ¼ of Section 32, Township 6 North, Range 14 West, Faulkner County, Arkansas.

PROPOSED SITE

COMMENCING at the Southeast corner of the Southwest ¼ of Section 32, Township 6 North, Range 14 West, Faulkner County, Arkansas and run North, a distance of 1,944.71 feet to a point;

THENCE, run East, a distance of 323.64 feet to the **POINT OF BEGINNING**, said point being the Eastern most point of the Proposed Site;

THENCE, run S48°38'09"W, a distance of 125.00 feet to a point;

THENCE, run N88°11'21"W, a distance of 143.67 feet to a point;

THENCE, run N48°38'09"E, a distance of 229.77 feet to a point;

THENCE, run S41°21'51"E, a distance of 98.30 feet to the **POINT OF BEGINNING**,

Proposed Site: Contains 0.40 acres and lies entirely within and is a part of the Northeast ¼, the Southeast ¼ and the Northeast ¼ of the Southwest ¼ of Section 32, Township 6 North, Range 14 West, Faulkner County, Arkansas.

BT-39

CENTERLINE DESCRIPTION OF A 40' WIDE PERMANENT RIGHT OF WAY & EASEMENT,

ACROSS THE PROPERTY OF THE CITY OF CONWAY.

Centerline Description of a Forty foot (40') wide Permanent Right of Way & Easement, extending over, through, along and across a tract of land lying within and being a part of the Northeast ¼, the Southeast ¼ and the Northeast ¼ of the Southwest ¼ of Section 32, Township 6 North, Range 14 West, Faulkner County, Arkansas as recorded in Book 430, Page 375, with the Office of the Clerk and Recorder of Faulkner County, Arkansas, the side lines of said Forty foot (40') wide Permanent Right of Way & Easement being lengthened or shortened to meet the Northern boundary of the aforesaid Proposed Site, all being more particularly described as follows:

Bearings are based off of a GPS observation transformed into NAD 83, Arkansas South Grid Datum.

COMMENCING at the Southeast corner of the Southwest ¼ of Section 32, Township 6 North, Range 14 West, Faulkner County, Arkansas and run North, a distance of 1,865.46 feet to a point;

THENCE, run East, a distance of 123.55 feet to the **POINT OF BEGINNING**, said point lying on the South boundary of the above described Proposed Site;

THENCE, run S 48°26'51" W, a distance of 310.58 feet to a point;

THENCE, run S01°43'59"E, a distance of 37.41 feet to the **POINT OF TERMINATION**, said point lying on the South boundary of the aforesaid tract, being common with the North right of way line of Union Pacific Railroad, said

point being 1,622.06 feet North and 107.74 feet West of said Southeast corner of the Southwest ¼.

Permanent Easement: Contains 0.32 acres and lies entirely within and is a part of the Northeast ¼, the Southeast ¼ and the Northeast ¼ of the Southwest ¼ of Section 32, Township 6 North, Range 14 West, Faulkner County, Arkansas.



A handwritten signature in blue ink that reads "Garland D. Herring".

Garland D. Herring, PS 1260

Hatch Mott MacDonald | Pipelines Unit
101 Crosley Street, West Monroe, LA 71291
T [318.329.0095](tel:318.329.0095) C [318.737.0709](tel:318.737.0709) F [318.329.0096](tel:318.329.0096)





City of Conway, Arkansas
Ordinance No. O-16-_____

AN ORDINANCE AUTHORIZING PERSONNEL CHANGES WITHIN THE CONWAY PARKS AND RECREATION DEPARTMENT; AND FOR OTHER PURPOSES:

Whereas, the Conway Parks & Recreation Department has determined that there is a need to reorganize the department and is requesting the following reclassifications within the department; and

Whereas, these changes will enable the department to increase proficiency and to meet the growing demands of the public, which will provide a higher level of service to the citizens of Conway; and

Whereas, the reclassifications will have no financial impact to the 2016 Conway Parks and Recreation Budget; and

Whereas, the reclassifications will not affect the authorized staffing levels with the Conway Parks and Recreation Department.

NOW THEREFORE BE IT ORDAINED BY THE CITY COUNCIL OF THE CITY OF CONWAY, ARKANSAS, THAT:

Section 1. The authorized positions in the Conway Parks and Recreation Department are changed to reflect the following reclassifications:

- Reclassify one full time Recreation Supervisor to a full time Programs Manager
- Reclassify one full time Grounds Foreman position to a full time Expo Manager
- Reclassify one full time Secretary to a full time Administrative Assistant I

Section 2. The City of Conway shall appropriate an amount of \$ 1,637 from Parks and Recreation Part-Time Employee Salaries (001.140.5113) to the Conway Parks and Recreation Full Time Salaries (001.140.5111)

Section 3. All ordinances in conflict herewith are repealed to the extent of the conflict.

PASSED this 12th day of January, 2016.

Approved:

Mayor Tab Townsell

Attest:

Michael O. Garrett
City Clerk/Treasurer



City of Conway, Arkansas
Ordinance No. O-16-_____

AN ORDINANCE APPROPRIATING FUNDS & AUTHORIZING THE CITY TO ENTER AN AGREEMENT WITH WHITE-DATERS & ASSOCIATES FOR THE PROFESSIONAL SERVICE PROPOSAL FOR DON OWEN INFIELDS; AND FOR OTHER PURPOSES

Whereas, the Conway City Council has approved the project of the renovation of the adult softball fields at the Don Owen Softball Complex in the 2016 Parks A&P Funded Project List; and

Whereas, the Conway City Council has approved the professional service proposal from White-Daters & Associates, Inc. for 3 artificial turf infields at the Don Owen Softball Complex; and

Whereas, this project will be funded by the Conway Parks & Recreation A&P Funds.

NOW, THEREFORE, BE IT ORDAINED BY THE CITY COUNCIL OF THE CITY OF CONWAY, ARKANSAS THAT:

Section 1. The City of Conway hereby authorizes the Mayor to enter into an agreement with White Daters & Associates to provide professional services for the Don Owen Infields project.

Section 2. The City of Conway shall appropriate an amount of \$18,450 from Parks and Recreation A&P Fund Balance Appropriation (252-000-4900) to the Conway Parks Department Parks General CIP Account (252-157-5990).

Section 3. All ordinances in conflict herewith are repealed to the extent of the conflict.

PASSED this 12th day of January 2016.

Approved:

Mayor Tab Townsell

Attest:

Michael O. Garrett
City Clerk/Treasurer



Steve Ibbotson
Director

Parks and Recreation

10 Lower Ridge Road • Conway AR 72032
www.conwayparks.com

January 12, 2016

Mayor Tab Townsell and City Council
1201 Oak Street
Conway AR 72032

Re: Professional Service Contract for Don Owen Infields

Dear Mayor:

As you are aware, the City Council approved seven (7) projects to be completed with A&P funds. This project is slated to start mid-summer and hopefully will be completed before the fall season begins.

The results of this project will improve the conditions for our local leagues as well as allowing us to host various age groups for tournaments.

The Parks Department is requesting the approval of the attached proposal from White Daters for renovations of the infields at the Don Owen Complex.

Thank you for your consideration.

Sincerely,

Steve Ibbotson
Parks Director

SDI: rfs

W WHITE - DATERS & ASSOCIATES, INC.
24 Rahling Circle
D Little Rock, Arkansas 72223
Phone: 501-821-1667
A www.whitedaters.com

December 21, 2015

Mr. Steve Ibbotson, Parks and Recreation Director
City of Conway
10 Lower Ridge Road
Conway, AR 72032

Re: Proposal for 3 artificial turf infields at the adult softball fields at the Don Owen Sports Complex

Dear Mr. Ibbotson:

We are pleased to quote the following fee schedule for design and preparation of construction documents on the above referenced project. Please find the attached proposed Scope of Services and area to be surveyed.

Topographic Survey	\$ 2,000
Design Services	\$12,950
Bidding/ Construction Administration	<u>\$ 3,500</u>
Total	\$18,450

The above fees do not include environmental or geotechnical studies. Expenses (prints and mileage) will be billed at direct costs.

White-Daters & Associates, Inc. is ready to begin this project when the City of Conway is ready to issue a notice to proceed. We look forward to working with you on this project.

Respectfully submitted,

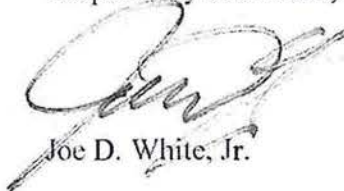

Joe D. White, Jr.

Accepted:

By: Mayor Tab Townsell

Date:



**City of Conway, Arkansas
Ordinance No. O-16-_____**

AN ORDINANCE APPROPRIATING FUNDS & AUTHORIZING THE CITY TO ENTER INTO AN AGREEMENT WITH GEORG ANDERSEN FOR THE MATERIALS FOR THE INTERIOR FINISHES AT THE CONWAY EVENT CENTER; AND FOR OTHER PURPOSES

Whereas, the Conway City Council has approved the cost of the materials for the interior finishes at the Conway Event Center; and

Whereas, this project will be funded by the Conway Parks & Recreation A&P Funds.

NOW, THEREFORE, BE IT ORDAINED BY THE CITY COUNCIL OF THE CITY OF CONWAY, ARKANSAS THAT:

Section 1. The City of Conway hereby authorizes the Mayor to enter into an agreement with Georg Andersen to provide the materials for the interior finishes at the Conway Event Center.

Section 2. The City of Conway shall appropriate an amount of \$288,427.50 from Parks and Recreation A&P Fund Balance Appropriation (252-000-4900) to the Conway Parks Department Parks General CIP Account (252-158-5990).

Section 3. All ordinances in conflict herewith are repealed to the extent of the conflict.

PASSED this 12th day of January 2016.

Approved:

Mayor Tab Townsell

Attest:

**Michael O. Garrett
City Clerk/Treasurer**



Steve Ibbotson
Director

Parks and Recreation

10 Lower Ridge Road • Conway AR 72032
www.conwayparks.com

January 12, 2016

Mayor Tab Townsell and City Council
1201 Oak Street
Conway AR 72032

Re: Approval of Interior Finishes for Event Center

Dear Mayor:

We have met with Georg Andersen and Rik Sowell to discuss the finishes for the Event Center.

I have attached the cost of the materials for the interior finishes. This includes furniture, lobby benches, wallcoverings and flooring.

I am requesting that the council approve the cost of the materials so that we can lock in this cost and prevent an increase at the time of bidding the project.

Thank you for your consideration.

Sincerely,

Steve Ibbotson
Parks Director

SDI: rfs

GEORG ANDERSEN

CONWAY, AR

NEW YORK, NEW YORK

December 21, 2015

Mayor Tab Townsell
Mr. Jack Bell
City Hall
Conway, AR 72032

RE: Conway Expo and Conference Center

RECAPITULATION

Estimate #36850Revised	Furniture – Virco	\$ 175,152.59
Estimate# 36852	Lobby benches	3,253.80
Estimate #36892	Wallcovering – Goods only	44,429.81
Estimate #36893	Flooring – Goods only	65,591.30
	TOTAL	\$ 288,427.50

NOTE: Estimate #36851 is enclosed as alternate to carpet squares.

2590 ADAMSBROOKE • CONWAY, AR 72034
501/327-7777

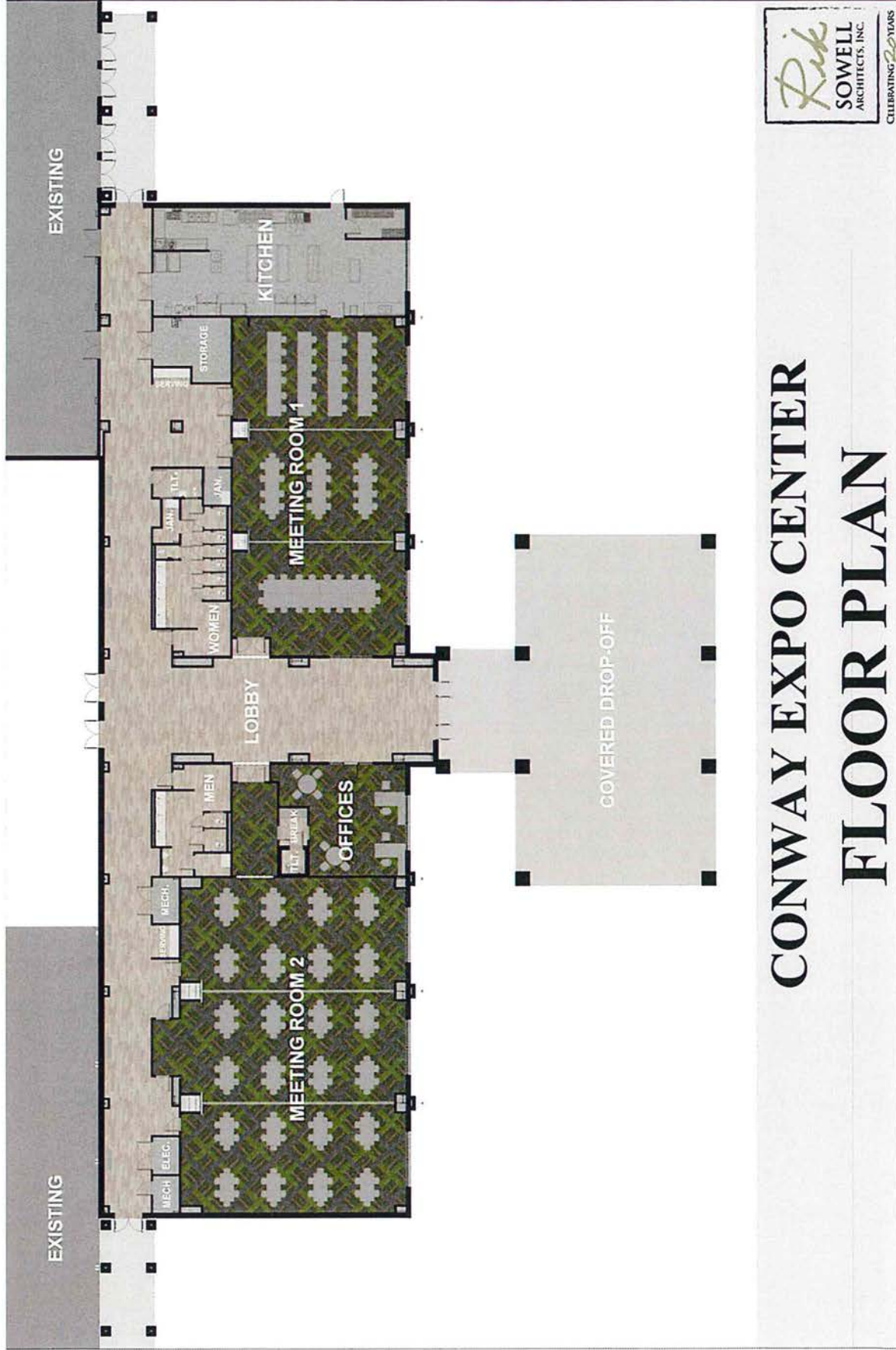

CONWAY EXPO CENTER FLOOR PLAN



SOCCER PARK LEASE AGREEMENT

This lease agreement made and entered into by and between the City of Conway (hereinafter “Lessor”), a city of the first class organized by the laws of the State of Arkansas, and Arkansas Rush (hereinafter “Lessee”), a nonprofit organization, on this ____ day of January, 2016 for the property commonly known as the Centennial Soccer Park (hereinafter “Soccer Park”).

WHEREAS, Lessor covenants that it is lawfully in possession of the Soccer Park; and

WHEREAS, the Lessor has the right and authority to execute this lease under the ability and authority granted by Arkansas Code Annotated § 22-4-501; and

WHEREAS, Lessor is the current operator of the Soccer Park described herein and wishes to lease said property to the Lessee; and

WHEREAS, it is the desire of the parties to enter into this Agreement for the purpose of reducing to writing the terms and conditions regarding the use of the leased premises and the respective obligations of the parties regarding ongoing maintenance; and

WHEREAS, that Lessee shall have the quiet and peaceful possession and enjoyment of the leased premises subject to the terms stated herein during the term of this Agreement; and

WHEREAS, for good and valuable consideration, the receipt and adequacy of which are hereby acknowledged, and in consideration of the mutual covenants and conditions between the parties, the parties hereby agree as follows:

1. LEASED PREMISES. Lessor shall lease unto Lessee the property owned by the Lessor, commonly known as the Centennial Soccer Park and located on John W Allison Road in Conway, Arkansas.

2. TERM. This Agreement shall commence on the ____ day of January 2016, and shall continue for fifteen (15) years, unless terminated as provided for in this Agreement. At the end of the original fifteen (15) year term, unless this Agreement has been terminated as provided for herein, Lessee shall have first right of refusal for an additional consecutive five (5) year terms.

3. TERMINATION. Either party may terminate this Agreement for any reason by giving the other party twenty four (24) months written notice within the first five (5) years of the initial term; thereafter during initial term or any approved additional term(s), a twelve (12) month written notification will be required. Any violation of this Agreement by the Lessee will be grounds for immediate termination by Lessor.

4. RENT. Rental for the term is in the amount of \$1.00 per year. Payment will be due at the time of signing and then upon the anniversary of the execution of this Agreement during the term of the lease.

5. USE OF THE PREMISES. The Soccer Park shall be used for the expressed and sole purpose of soccer leagues and other purposes consistent with soccer including but not limited to registration, practices, games, meetings, camps, tournaments, fundraisers and other soccer related activities, and for no other purpose unless expressly permitted in writing by the Lessor. Lessee will have full access and use of all fields, parking areas and facilities on the premises during the term of this Agreement subject to any limitations or exceptions contained herein. Lessee shall collect all monies paid for the use of the Soccer Park under the terms of this Agreement and use them in furtherance of their obligations listed herein. All other uses, and rates charged for such use, shall require approval of Conway City Council.

6. SOCCER PARK NAME. The name of the Soccer Park will remain "Centennial Soccer Park" during the term of this Agreement unless changed by the City Council. Reference to the Soccer Park on any schedules, on the Lessee's website or in any promotional/informational materials used by the Lessee will be done using the official name of the Soccer Park.

7. AVAILABILITY FOR OTHER USERS. Lessee will provide times for the general public and Lessor sponsored programs and sports to use the Soccer Park. The schedule shall be posted conspicuously at the Soccer Park and on the Lessee's website at all times, and provided to the Parks and Recreation Department director and/or his or her designee. All Lessor sponsored programs and sports schedules will be provided to Lessee by January 30th of each year. Lessee will make as many fields available as necessary to accommodate these programs and sports. Furthermore, the Lessee agrees that its possession and use of the Soccer Park is subject to the attached Soccer Park User Agreements and that Lessee will treat those agreements as continuing obligations throughout the term of this Agreement. Lessee shall collect all usage fees in accordance with Section 5 of this Agreement. All usage rates are to remain at current levels throughout the term of this Agreement

unless increases are approved by the City Council. The Soccer Park User Agreements incorporated and attached hereto include:

- i. City of Conway and Arkansas United Soccer, executed June 24, 2014 (Exhibit 1)
- ii. City of Conway and Central Baptist College, executed August 31, 2015 (Exhibit 2)
- iii. City of Conway and St. Joseph School, executed February 4, 2015 (Exhibit 3)

8. MAINTENANCE. Lessee will not do anything or allow anything to be done to the Soccer Park either intentionally or by acquiescence that would in any way damage or impair the fields, parking areas, structures, equipment or facilities. Lessee shall, at its own expense, and at all times, maintain the Soccer Park in a clean and sanitary condition and maintain and repair the interior space(s) of the Soccer Park including, but not limited to, heating and air conditioning equipment, lighting, plumbing, wiring, walls, windows, floors and ceilings. Lessee shall maintain the grass located at the Soccer Park in accordance with Exhibit 4 attached hereto.

9. IMPROVEMENTS/REPAIRS. The Soccer Park is being leased in an "As-Is" condition. Lessor makes no warranties or guarantees as to premise, facilities, equipment or systems. Lessee acknowledges it has had a sufficient opportunity to inspect the Soccer Park and has determined it is suitable for its purposes. The Conway City Council must approve repairs or improvements costing \$2,500.00 or more. Lessee must provide proof of funds at the time of the request for approval of repairs or improvements costing \$2,500.00 or more. Regardless of the estimated cost of the repair or improvement, notice will be provided to the Lessor by the Lessee of the nature of the repair or improvement, date(s) the repair or improvement are scheduled to begin and estimated cost of the repair or improvement. All improvements or repairs to the facility will be required to meet the most recent building codes and will be subject to inspection by Lessor. In the case of an emergency repair requiring immediate attention to prevent further loss and/or damage to the property, this provision maybe be waived in a writing by the Lessor after notification from the Lessee. All permanent improvements to the Soccer Park will remain with the property after termination of this Agreement at no cost to the Lessor.

10. CONSENT TO REASONABLE ENTRY. Lessee consents, whether Lessee or Lessee's customers, agents, servants, occupants, invitees, licensees, or guests are present or not, to entry of the Soccer Park at reasonable times for reasonable purposes, by Lessor, Lessor's representatives, repair persons, or service persons.

11. UTILITIES/ON-GOING EXPENSES. Lessee will be responsible for scheduling the hookup and paying of deposits and future charges, as and when due, of all of the utilities, including, but not limited to, electric,

water, gas, telephone, internet, and TV cable. Lessee will at all times keep electric, water, trash (and gas, if applicable) service to the Soccer Park. If such service is discontinued for any reason, Lessor may reinstate such service and charge the cost of such reinstatement and utility service to Lessee.

12. INSURANCE. Lessor has and will continue to maintain an insurance policy covering the Soccer Park. Lessee will be required to have in place at all times while this Agreement is in effect an insurance policy with minimum coverage and limits as listed below. Such insurance policy or policies will list Lessor as an additional insured. Proof of said insurance coverage will be provided to Lessor upon each policy renewal. If the coverage is cancelled or not renewed for any reason, Lessee will immediately notify Lessor and all Lessee operations will cease until replacement coverage can be obtained.

- i. General Liability coverage in an amount not less than \$1,000,000 general aggregate and \$1,000,000 per occurrence for general liability, bodily injury, personal injury, and property damage.
- ii. Workers' Compensation insurance as required by the State of Arkansas and Employer's Liability Insurance.

13. INDEMNIFICATION. Lessee shall indemnify, hold harmless, and defend, with counsel acceptable to Lessor, the Lessor (including its elected officials, officers, agents and employees) from and against any and all claims (including all litigation, demands, damages, liabilities, costs, and expenses, and including court costs and attorney's fees) resulting or arising from performance, or failure to perform, under this Agreement or from the use of the Soccer Park by the Lessee, Lessee's customers, participants, agents, servants, employees, occupants, invitees, licensees or guests.

14. LIABILITY. Lessor will not be liable to Lessee or Lessee's customers, agents, servants, occupants, invitees, licensees, or guests for any damages or losses to persons or property caused by other persons, including, but not limited to, negligence, theft, burglary, vandalism, or other crimes. Lessor will not be liable to Lessee or Lessee's customers, agents, servants, occupants, invitees, licensees, or guests for personal injury or for damage to or loss of personal property from fire, flood, water leak, rain, hail, ice, snow, smoke, lightning, wind, explosion, interruption of utilities, or other occurrences. Lessee shall secure insurance to protect against any and/or all of the above occurrences.

15. DEFAULT. Should either party default in the performance of any obligation created by this Agreement, and remain in default for a period of time in excess of ten (10) days after notice from the other of such default, the non-defaulting party may declare this lease terminated.

counterparts, each of which shall be deemed an original, but which together shall constitute one and the same instrument.

21. ASSIGNMENT AND SUBCONTRACTING. This Agreement and the performance hereunder shall not be assigned or subcontracted without written consent of the Lessor.

EXECUTED this _____ day of January 2016.

CITY OF CONWAY
LESSOR

By: _____
MAYOR TAB TOWNSELL

ATTEST:

MICHAEL O. GARRETT, CITY CLERK/TREASURER

ARKANSAS RUSH SOCCER
LESSEE

By: _____
NATHAN HUNT, PRESIDENT



**City of Conway, Arkansas
Resolution No. R-16-_____**

**A RESOLUTION ADOPTING THE ORGANIZATIONAL RULES AND PROCEDURES FOR THE CONWAY
CITY COUNCIL FOR THE CALENDAR YEAR 2016**

Whereas, by state law city councils are charged with organizing their proceedings and setting their rules; and

Whereas, City councils are task to set their organizational rules and procedures at the first business meeting every year.

**NOW, THEREFORE, BE IT HEREBY RESOLVED BY THE CITY COUNCIL OF THE CITY OF
CONWAY ARKANSAS THAT**

Section 1. The Conway City Council shall formally adopt the rules and procedures of its long standing traditions and its general adherence to Robert's Rules of Order as written in the Rules & Procedures for Conway City Council, January 2016 document presented at the January 12th, 2016 City Council meeting.

PASSED this 12th day of January, 2016.

Approved:

Mayor Tab Townsell

Attest:

**Michael O. Garrett
City Clerk/Treasurer**

Rules & Procedures
Conway City Council
January 2016

THE CONWAY CITY COUNCIL RULES AND PROCEDURES:

City Council Jurisdiction:

The City Council shall possess all legislative powers granted by state law to cities of the first class and other corporate powers of the city not prohibited in state law or by some ordinance of the city council made in pursuance of the provisions therein and conferred on some officer of the city. [A.C.A. 14-43-502(a)]

The City Council shall have the management and control of finances, and of all real and personal property belonging to the corporation. [A.C.A. 14-43-502(b)(1)]

City Council Meetings:

City Council meetings are always open to the public. [A.C.A. 14-43-502 (b)(2)(A)]

The City Council shall conduct regular business meetings at 6:30pm in the Judge Russell L. "Jack" Roberts District Court building located at 810 Parkway on the second and fourth Tuesdays of each month. The City Council by majority vote may reschedule or cancel such meeting as it deems necessary on a meeting by meeting basis. [A.C.A. 14-43-502 (b)(2)(A)]

Special or emergency meetings of the City Council may be called by the Mayor or any three (3) alderman by signed submittal of time and place of the scheduled meeting and its agenda to the Mayor or Mayor's Office, City Clerk or City Clerk's office, or the City Attorney, or the City Attorney's office in a timely manner to fully comply with the two hour notification requirement [A.C.A. 25-19-106(6)(2)] for all media and for the same notification of all elected city officials. Notification shall be deemed given when those to be notified have been contacted or when an attempt to contact them has been made by the proper time, by every means of instant communications they have been submitted for notification purposes. All means of communication for notification purposes within a timely reason should be attempted regardless.

Agenda for City Council Meetings:

Agenda items shall consist of all items of city business needing city council approval, judgment or review arising out of the city budget; city departments; City Council committees; city committees, boards, and commissions; and all city systems and processes submitted for the purpose of city council action according to the procedures herein described. Agenda items may also be submitted by the Mayor or any Alderman following the procedures herein described for consideration at any city council meeting. Planning Commission items are automatically forward to the Mayor's Office for inclusion on the Agenda.

The Agenda is prepared by the Mayor's Office. All Agenda items for consideration at regular City Council meetings must be submitted to the Mayor's Office by 12:00pm no later than 7 days prior to the City Council meeting. Items may be included later with the Mayor's approval; however, the published Agenda shall not include items submitted after 12:00pm the Friday before the Tuesday City Council meeting. All items should be submitted electronically (if applicable) with all necessary documentation including ordinances and/or resolutions.

The City Council may by a non-debatable two-thirds majority vote add an item of business to any regular, special, or emergency City Council meeting

Preparation of the Agenda packet for each regular City Council meeting should be completed and the Agenda published before close of business on Friday before the Tuesday City Council meeting. An electronic copy shall be sent to the each Alderman, Department Head, and made available on the city's website (www.cityofconway.org). An electronic copy is also sent to any person's requesting the agenda on the "E-Agenda Email listing". This schedule may change for rescheduled meetings and does not apply to special meetings.

Conduct of the City Council Meeting:

The Mayor shall be the ex officio President of the City Council and shall preside at its meetings regular and special. [A.C.A. 14-43-501 (b) (1) (A)]

A quorum is defined as a majority of all Aldermen on the City Council.

The City Council may from as necessary compel the attendance of absent members in such a manner and under such penalties as they think fit to prescribe [A.C.A. 14-43-501 (a)(2)(C)(ii)]

The Mayor shall have a vote to establish a quorum at any regular meeting of the City council and when his or her vote is needed to pass any ordinance, by-law, resolution order, or motion. [A.C.A. 14-43-501 (b) (1) (B)]

In the absence of the Mayor, Alderman Andy Hawkins is elected president pro tempore to preside in his absent. If Alderman Hawkins is unavailable to preside in the Mayor's absence, the alderman present at the meeting shall elect a temporary president pro tempore to preside for that one meeting. [A.C.A. 14-403-501 (b) (2)]

Business shall be conducted by Roberts Rules of Order. However, it is to be understood that parliamentary procedure is not the goal. The goal is respectful conduct of business in equitable order. It is also understood that formal parliamentary procedure is not well known. Therefore, an informal form of procedure can be used provided that equity and order is maintained. If a question of order arises or if so requested by an alderman, the Mayor shall implement formal parliamentary procedure.

A positive motion is encouraged to start consideration of each business item.

Ordinances by state law are required to be read at three separate council meetings before being considered for action unless the various readings are waived by Council. The Council can choose to waive any or all readings of an ordinance when it comes up on the agenda by a non-debatable two third majority voice vote. [A.C.A. 14-55-202]

Ordinances shall require a roll call vote. Emergency clauses associated with ordinances shall require an undebatable separate roll call vote and with a two-third majority approval. The City Clerk shall maintain a random roll call list of aldermen for each separate business item requiring a roll call vote (Ord. No. O-02-200).

Resolutions and all other motions of the Council may be approved by voice vote. A show of hands will be required on all non-unanimous votes to properly record the votes in the record.

Discussion and Citizen Commentary:

Debate on Agenda items appearing before the City Council is reserved for the City Council. Citizen commentary at council meetings is allowed in specific situations and under conditions allowed by the City Council herein described.

While the City Council generally wishes for public input and public participation and publishes their individual contact information through the City, this willingness does not constitute an unrestricted right to speak at meetings of the Council.

Petitioners and City Officials: Petitioners and city officials appearing before the City Council regarding items of business arising from the agenda or placed on the agenda are recognized by the Council as having a right to speak to their petition or report subject to restriction thereof.

City Council members and the Mayor may ask questions from time to time from petitioners, city officials, or the public. Those questioned will be allowed to answer subject restriction thereof.

General Citizenry: The City Council restricts citizen input at any regular or special meeting to germane commentary regarding items of business before the Council arising from the meeting agenda or from the Council's placement of an item on the agenda. Citizen commentary may only occur at such time as the item of business is before the Council and under consideration for action. It is the City Council's intention to allow public input in an informal format with due regard to the equity of allowing the various sides of issues to speak and, within reason, with due regard to the number of people wishing to address the Council.

The Mayor as ex-officio president of the Council shall allow citizen input on a per business item basis provided that individual speakers are recognized in turn, identify themselves for the record and address the Council from a podium and/or position established for such. Unrecognized comments from the audience are prohibited. The City Council may at any time restrict such citizen input in any fashion including, but not limited to, the length of individual comments, the total number of speakers, and/or the total time allotted for public input.

At all times, an open conversation with or within the audience is strongly discouraged. Redundancy of commentary is strongly discouraged. More than one speaker at a time prohibited.

Non Agenda Commentary: The City Council may suspend the rules of order and allow citizen input/commentary on matters not included on the Agenda of the City Council meeting. Suspending the rules of order requires a non-debatable two-third majority vote.

The Disability or Absence of the Mayor:

If the Mayor is unable to perform the duties or cannot be located, Jack Bell, Chief of Staff, is designated by the Mayor and approved by the City Council to perform all functions of a Mayor during the disability or absence of the Mayor. [A.C.A. 14-43-501(b)(3)(C)]

For the purpose of this section "disability" and "absence" are defined herein:

Disability: Disability is defined as the inability to perform the duties of the office as determined by City Council. Disability can be either physical or mental and be requested consensually by the Mayor or imposed non-consensually by the City Council.

A consensual disability may be requested in writing by the Mayor. In such voluntary cases a simple majority vote of the City Council can approve a finding of disability and authorize the above named designee to assume the duties of the Office of the Mayor.

A non-consensual finding of disability regarding the Mayor may be submitted to the City Council for their consideration at any regular or special meeting following the normal agenda procedures herein set forth. The Mayor, the Chief of Staff of the Mayor's Office, the City Clerk, the City Attorney, the Mayor's family or person(s) representing the interest of the Mayor and/or the person(s) having power of attorney over the Mayor's affairs if known shall be notified of such a submittal for City Council consideration as soon as possible but no later than the timeline requirements for notifying the media of any special meeting. The Mayor or designee shall have the right to address the City Council regarding the issue of disability. A finding of non-consensual disability will require a *debatable* two-third vote of the City Council and should be based on cause. Non-consensual findings of disability are appealable to Circuit Court.

Findings of disability are allowed only for a specified period of time not to exceed 30 days. At the expiration of such a period the City Council can extend the finding by two-third majority of City Council again appealable to Circuit Court or let the previous finding expire. A finding of disability

may be terminated at any time by a majority vote of the City Council. In cases of the expiration or the termination of the finding of disability the Mayor shall immediately assume the duties of the office.

Absence: Absence is defined as the inability to locate the Mayor and an inability to communicate with the Mayor including a reasonable expectation that the Mayor cannot or will not be located or that communications cannot or will not be established with the Mayor in a reasonable and timely fashion. The rules and procedures regarding the finding of a non-consensual disability shall apply except that 1.) There is no maximum length of time set for a finding of absence or 2.) The finding of absence is automatically terminated by any direct communication between the Mayor and the Chief of Staff, City Clerk, or the City Attorney provided there is a reasonable expectation of continued communication. Findings of absence are appealable to Circuit Court.